

Assembly Instructions

Medium Duty (Single Rail) 624601

**Quality Fabricators**[®]
| **ZRACKS.COM**

1-877-637-3712

PARTS LIST

1. Horizontal Hanging Bar (x1)
2. Vertical Support Bar (x2)
3. Frame Cross-Bar (x1)
4. End Frame (x2)
5. Caster (x4)
6. Caster Bumper (x4)
7. Nut (x4)
8. Bolt (x4)
9. Washer (x4)

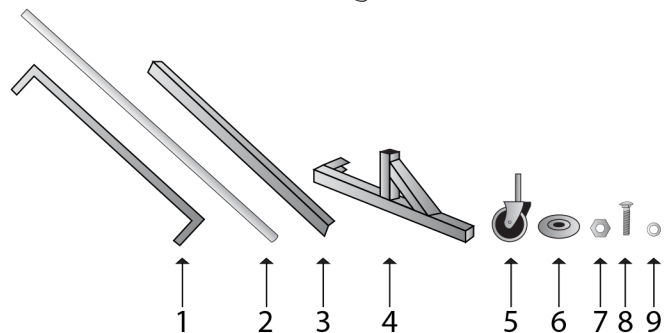
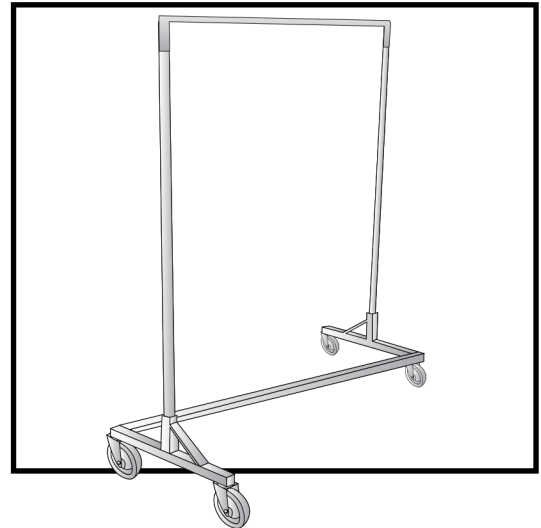

ASSEMBLY INSTRUCTIONS

1. Remove the included washers and bolts from the frames, using the included Allen wrench. (Figure 1)
2. Slide the frame and the frame cross-bar together, aligning the bolt holes. (Figure 2)
3. Insert bolts into aligned bolt holes, placing the washers between the frame and bolt. Tighten using the included Allen wrench. (Figure 3)
4. Place rubber bumpers on casters with concave side toward caster.
5. Align and insert casters with rubber bumpers. Tighten bolt on opposite side using included wrench. (Figure 4)
6. Insert the vertical support bars into the frame. (Figure 5)
7. Slide horizontal hanging bar on to top of the vertical support bars and lock into place. (Figure 6)

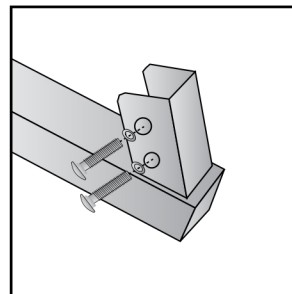

Figure 1

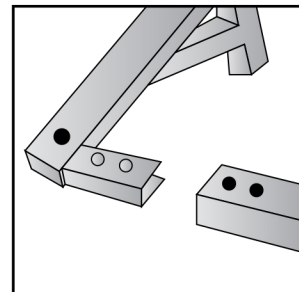

Figure 2

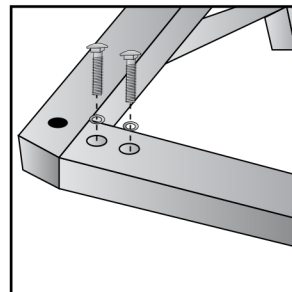

Figure 3

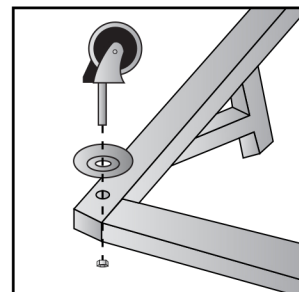

Figure 4

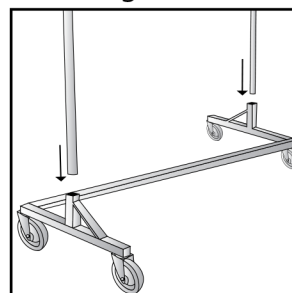

Figure 5

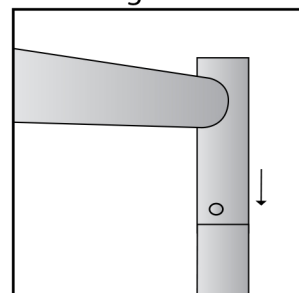

Figure 6