

TASCAM

D01354020C

DR-40X

Linear PCM Recorder

REFERENCE MANUAL

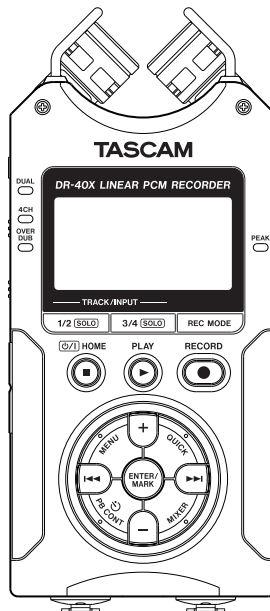

Table of Contents

1 – Introduction	4	Independent L/R channel EXT IN input level setting function.....	27
Features.....	4	Using the LEVEL MODE function.....	27
Conventions used in this manual.....	4	Overview of recording modes.....	28
Trademarks and copyrights.....	5	Recording (MONO/STEREO recording).....	28
About SD cards.....	5	Make recording settings.....	28
Precautions for use.....	5	Setting where files are saved.....	29
2 – Names and Functions of Parts	6	Starting the recording.....	29
Top panel.....	6	File names when recording in MONO/STEREO.....	29
Front panel.....	8	Simultaneously recording two files at different input levels (DUAL REC).....	30
Left side panel.....	8	Enabling dual recording.....	30
Right side panel.....	8	Starting dual recording.....	31
Bottom Panel.....	9	Dual recording file names.....	31
Home Screen.....	10	Recording 3 or 4 channels.....	31
Recording screen.....	11	Making settings for 3/4-channel recording.....	31
Menu item list.....	13	Starting 3/4-channel recording.....	32
Using the menu.....	14	File names when recording in 4-channel.....	32
Basic operation.....	15	Recording playback and input sounds together (overdubbing).....	33
3 – Preparation.....	16	Setting the overdubbing mode.....	33
Powering the unit.....	16	Select the file you want to overdub.....	34
Using AA batteries.....	16	Conducting overdubbing.....	34
Using an AC adapter (sold separately).....	16	File names when overdubbing.....	34
Using USB bus power.....	16	Using the automatic recording function (AUTO REC).....	35
Turning the power on and off (standby mode).....	17	Continuing to record in a new file (track incrementing).....	36
Turning the unit on.....	17	Manually incrementing files during recording.....	36
Turning the unit off (standby).....	17	Automatically incrementing files by a set time.....	36
Resume function.....	17	Using the low-cut filter.....	37
Setting the date and time.....	18	Capturing a few seconds before starting recording (PRE REC).....	37
Inserting and removing SD cards.....	19	Using tone output.....	38
Inserting cards.....	19	Setting the AUTO TONE function.....	38
Removing the card.....	19	Setting the AUTO TONE length.....	38
Card write protection.....	19	Adjusting the AUTO TONE volume.....	38
Preparing an SD card for use.....	19	Self-timer function.....	39
Using the built-in speaker.....	20	Solo function.....	39
Connecting monitoring equipment.....	20	Recording duration.....	40
Using the built-in microphone.....	21	5 – Working with Files and Folders (BROWSE screen)	41
Setting the mics to record a wide stereo sound (A-B position).....	21	Screen navigation.....	41
Setting the mics to record a clear stereo sound (X-Y position).....	21	Icons on the BROWSE screen.....	41
Swapping the left-right channels of the built-in microphone pair.....	22	File operations.....	41
Microphone position detection.....	22	Folder operations.....	43
Attaching the tilt foot.....	22	Creating a new folder.....	43
4 – Recording	23	6 – Playback.....	44
Setting file format and sampling frequency (REC SETTING).....	23	Adjusting the playback volume.....	44
Preparing the recording inputs.....	24	Setting the playback area (AREA).....	44
Recording with the built-in mics.....	24	Selecting a folder for the playback area (1).....	45
Recording with external mics (EXT MIC IN).....	24	Selecting a folder for the playback area (2).....	45
Recording an external device (LINE IN).....	24	Using the playlist.....	46
Setting the external input type.....	24	Adding files to the playlist.....	46
Using phantom power.....	25	Editing the playlist.....	46
Adjusting the input level.....	25	Selecting files for playback (skipping).....	47
Manually adjusting the input level.....	25	Playing recordings.....	47
		Pausing.....	47

Stopping playback	47
Searching backward and forward	47
Repeating playback (REPEAT)	48
Special playback control functions	48
Playback Control screen	48
Loop playback of a selection	48
Changing the playback speed (VSA)	49
Setting the playback equalizer	50
Increasing perceived sound pressure to enhance listen- ability (LEVEL ALIGN)	50
Using the jump function	51
Setting the jump back time	51
Setting the jump forward time	52
Playback of files recorded using dual recording	52
OVERDUB INPUT MUTE function (during playback)	52
Solo function	52
7 – Quick Operations	53
Features of the QUICK button	53
Quick menu	55
Deleting files	55
Dividing the selected file (DIVIDE)	55
Dividing the selected file automatically at marks (AUTO DIVIDE)	56
Overwrite recording	57
Selecting a file to overwrite record	57
Activating overwrite mode	57
Conducting overwrite recording	57
Checking the result of recording	57
Undoing and redoing (UNDO/REDO)	57
Ending overwrite recording mode	57
Transcribing recorded files (DICTATION PLAY)	58
Enabling DICTATION PLAY mode	58
Adjusting playback equalization	58
Changing the playback position	58
Ending DICTATION PLAY mode	58
Mixdown	59
8 – Mark functions	60
Adding marks manually	60
Adding marks automatically to a recording	60
Moving to mark positions	60
Clearing marks	60
9 – Using effects	61
Setting the effect	61
Effects preset list	61
10 – Mixer	62
Making mixer settings	62
Using the MS decoder	63
Decoding the input sound as you record	63
Decoding the playback sound	63
MS decoder settings	63
11 – Tuning Instruments	64
Using the tuner	64
Setting the tuner	64
Tuning a musical instrument	64
12 – USB Connections	65
Powering the unit with USB bus power	65
Using as an SD card reader	65
Disconnecting the unit from a computer	66
Transferring files from a computer	66
Using as a USB audio interface	66
The AUDIO I/F screen will open	66
Setting the connected device type	67
Connecting	67
13 – Settings and Information	68
Viewing information (INFORMATION)	68
File information page	68
Card information page (CARD)	68
System information page (SYSTEM)	68
System Settings	69
Setting the automatic power saving function	69
Setting the backlight	69
Adjusting the display contrast	69
Setting the battery type	69
Setting the phantom power voltage	69
Setting the language	69
Restoring the factory settings	70
Formatting SD cards	70
Completely formatting SD cards	70
Setting the file name format	71
File name format	71
Setting the WORD item	71
Resetting the number	71
14 – Using the REMOTE jack	72
Footswitch (TASCAM RC-3F)	72
Setting footswitch operation	72
Using the footswitch	72
Remote control (TASCAM RC-10)	73
Setting the wired remote control	73
Using the wired remote control	73
15 – Messages	74
16 – Troubleshooting	76
17 – Specifications	77
Ratings	77
Input/output ratings	77
Analog audio input and output ratings	77
Control input/output ratings	77
Audio performance	77
Other specifications	77
Dimensional drawings	79

1 – Introduction

Features

- Compact audio recorder that uses SD/SDHC/SDXC cards as recording media
- High-performance directional stereo mics can be adjusted, enabling both A-B and X-Y recording
- Can record with different types of stereo sound depending on the angle of the microphones
 - Closed (X-Y): clear stereo sound with less phase difference
 - Open (A-B): wide stereo sound
- Mid-side decoding function can be used with MS mics
- Recording of up to four channels simultaneously possible
- 44.1/48/96 kHz, 16/24-bit, linear PCM (WAV format) recording possible
- Compatible with BWF format
- 32–320 kbps MP3 format recording possible (compatible with ID3 tag v2.4)
- Dual recording allows two files to be recorded simultaneously at different levels
- Overdubbing in mix mode allows the playback signal and the input signal to be mixed and recorded as a new file
- Overdubbing in separate mode allows the playback signal and the input signal to be mixed and recorded as a new file, while saving the original file
- Built-in 0.3 W monaural monitor speaker
- Built-in effect (reverb) can be used during recording and playback
- Auto-record function starts recording automatically when a set sound input level is detected
- Tone output function convenient for synchronizing with video files when editing
- A **QUICK** button is available for easy access to various functions
- Track incrementing function allows a recording to be split by creating a new file when desired
- Pre-recording (PRE REC) function allows the unit to record the 2 seconds of sound before recording is activated
- Automatic peak reduction function automatically reduces the level suitably when the input level is too high
- Automatic level control is available to increase or decrease the recording volume when the input sound is too low or too high, respectively.
- Limiter function automatically reduces the level suitably in particular portions where the input level is too high
- Low cut filter conveniently reduces low-frequency noise
- VSA function can change playback speed in a range from 50-200% (0.5 to 2.0 in 0.1 increments) of normal without changing pitch
- Repeat playback and IN-OUT loop playback functions
- **PB CONT** button opens screen for playback speed and IN-OUT loop settings
- Tuner function to tune musical instruments

- Self-timer function to start recording after a set period of time.
- Jump function that moves backward or forward a small amount during playback or when paused (DICTATION PLAY mode only)
- Delay compensation function that eliminates time lags caused by differences in the distances of two sets of inputs from the sound source
- Playlist function
- MARK function convenient for moving to specific locations
- DIVIDE function allows files to be split where desired (only for WAV files)
- Equalizers function for playback, and level alignment function to enhance the perceived overall sound pressure
- File name format can be set to use a user-defined word or the date
- Resume function remembers the playback position before the unit was turned off (put in standby)
- 3.5 mm (1/8") line/headphones output jack
- 128×64-pixel LCD with backlight
- Micro-B type USB 2.0 port
- Operates on 3 AA batteries, an AC adapter (sold separately: TASCAM PS-P520E), or USB bus power
- Tripod attachment screw-hole built into unit
- Two balanced mic/line inputs (XLR/TRS combo jacks)
- USB audio interface functions
- Dictation playback mode
- Overwrite recording function

Conventions used in this manual

The following conventions are used in this manual.

- When we refer to a button or connector or control on the DR-40X, the typeface looks like this: **MENU**.
- When we show messages, for example, that appears on the unit's display, the typeface looks like this: **REPERT**.
- SD, SDHC and SDXC memory cards are called "SD cards".
- Words that appear on the computer display are shown in quotation marks like this: "**DR-40X**".
- Additional information is provided as necessary in tips, notes and cautions.

TIP

We give hints and tips on using the DR-40X when you see this icon.

NOTE

Notes provide additional explanations for special situations.

CAUTION

Failure to follow these instructions could result in damage to equipment or lost recording data, for example.

CAUTION

Failure to follow these instructions could result in injury.

Trademarks and copyrights

- TASCAM is a trademark of TEAC CORPORATION, registered in the U.S. and other countries.
- SDXC Logo is a trademark of SD-3C, LLC.



- The MPEG Layer-3 audio coding technology is licensed from Fraunhofer IIS and Thomson.
- Supply of this product does not convey a license nor imply any right to distribute MPEG Layer-3 compliant content created with this product in revenue-generating broadcast systems (terrestrial, satellite, cable and/or other distribution channels), streaming applications (via Internet, intranets and/or other networks), other content distribution systems (pay-audio or audio-on-demand applications and the like) or on physical media (compact discs, digital versatile discs, semiconductor chips, hard drives, memory cards and the like). An independent license for such use is required. For details, please visit <http://mp3licensing.com>.
- ASIO is a trademark of Steinberg Media Technologies GmbH.



- Other company names, product names and logos in this document are the trademarks or registered trademarks of their respective owners.

About SD cards

This unit uses SD cards for recording and playback.

A list of SD cards that have been confirmed for use with this unit can be found on the TEAC Global Site (<http://teac-global.com>). Check the page for this product. You can also contact TASCAM customer support service.

Precautions for use

SD cards are delicate media. In order to avoid damaging SD cards, please take the following precautions when handling them.

- Do not leave them in extremely hot or cold places.
- Do not leave them in extremely humid places.
- Do not let them get wet.
- Do not put things on top of them or twist them.
- Do not hit them.
- Do not remove or insert them during recording, playback, data transmission or other access.
- Always put memory cards in cases when transporting them.

2 – Names and Functions of Parts

Top panel

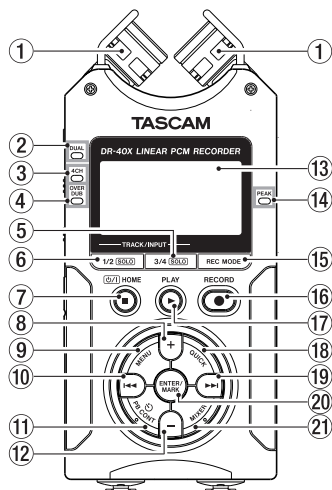

① Built-in stereo microphone

This is a stereo pair of unidirectional electret condenser mics. You can set the microphones to open (A-B) or closed (X-Y).

② DUAL indicator

This lights orange when recording in dual recording mode.

③ 4CH indicator

This lights orange when recording in 4-channel recording mode.

④ OVER DUB indicator

This lights orange when recording in overdubbing mode.

⑤ 3/4 [SOLO] button

When in 4-channel recording mode, press this to open a display pull-up that shows meters with the input level settings for 3/4.

Press when the 1/2 input level meter pull-up is displayed to switch to the 3/4 input level meter pull-up.

Press and hold when recording or playing back in DUAL or 4CH mode to use the solo function, which switches the monitored sound to sources other than channels 1 and 2.

Press and hold to solo channels 3 and 4.

Press the 3/4 [SOLO] button to switch between the input sound and the 3/4 track playback sound.

⑥ 1/2 [SOLO] button

Press this to open a display pull-up that shows meters with the input level settings for 1/2.

Press when the 3/4 input level meter pull-up is displayed to switch to the 1/2 input level meter pull-up.

Press and hold when recording or playing back in DUAL or 4CH mode to use the solo function, which switches the monitored sound from other sources to channels 1 and 2.

Press and hold to solo channels 1 and 2.

Press when in OVERDUB (MIX) recording mode to mute the input sound.

⑦ (HOME) [■] button

Press this button during playback to cause the playback to pause at the current position. Press this button during pause time to return to the beginning of the playback file. Press this button during recording or recording standby to cause the recording to stop.

When any other screen is open, press this button to return to the Home screen. Use this button to answer "NO" to a confirmation message.

Press and hold to turn the unit on and off (put into standby).

⑧ + button

When the Home screen is displayed, press this button to increase the output level from the built-in speaker or Ω /LINE OUT jack. During adjustment, a volume indicator will be displayed in a pull-up window.

When the Playback Control screen is open, press to increase the playback speed.

When a setting screen is open, use the button to change the setting of the selected item.

⑨ MENU button

When the Home Screen is open, press this to open the MENU screen.

Press this button to return to the MENU screen from the various setting screens.

When the IN and OUT points are set in the file and the Playback Control screen is displayed, press this button to turn on or off loop playback.

⑩ button

Press this button to return to the beginning of a playback file that is playing or stopped in the middle.

When the IN and OUT points are set between the current position and the beginning of the playback file, pressing this button skips to those points.

If you press this button when a file is stopped at its beginning, the unit will skip to the beginning of the previous file.

Press and hold to search backwards.

Press this button while pressing and holding the ENTER/MARK button to return to the previous mark.

On the setting screens, use this button to move the cursor left.

On the BROWSE screen, press this button to move up a level.

⑪ PB CONT button

This button activates the Playback Control screen.

When the Playback Control screen is open, press to return to the Home screen.

Press during recording standby to turn off the self-timer function or change the time period.

⑫ - button

When the Home screen is displayed, press this button to decrease the output level from the built-in speaker or Ω /LINE OUT jack.

During adjustment, a volume indicator will be displayed in a pull-up window.

When the Playback Control screen is open, press to reduce the playback speed.

When a setting screen is open, use the button to change the setting of the selected item.

⑬ **Display**

Shows a variety of information.

⑭ **PEAK indicator**

Lights when the input volume is too high.

⑮ **REC MODE button**

Press this button to open the REC MODE screen.

When the REC MODE screen is open, press this button to return to the Home screen.

⑯ **RECORD [●] button/REC indicator**

When stopped, press this button to put the unit into recording standby. The REC indicator will start to blink.

Press when recording to pause recording.

⑰ **PLAY [►] button**

When the Home screen is displayed and playback is stopped, press this button to start playback.

During playback, press this button to start jump-back playback.

⑱ **QUICK button**

When playing back, stopped, paused or in recording standby in the Home screen or when the Playback Control screen is displayed, press this button to display the Quick Menu screen. The function to be shown depends on the state of the unit when the button is pressed.

- Stopped: delete, division, level alignment, or mixdown for the current playback file
- Playing back/playback control screen: level alignment function
- Recording standby: LEVEL MODE function, swap left and right built-in mics

Mixer Screen: MS decoder setting

When the BROWSE screen or PLAWLIST screen is open, press this button to open or close the pop-up menu for file/folder operations.

⑲ **▶▶I button**

Press this button during playback or when playback is stopped to skip to the beginning of the next file.

When the IN and OUT points are set between the current position and the end of the file, pressing this button skips to those points.

Press and hold this button to search forward.

On the setting screens, use this button to move the cursor right.

Press this button while pressing and holding the **ENTER/MARK** button to move to the next mark.

On the BROWSE screen, press this button to move down a level. If a file is selected, the file is loaded, the Home Screen reopens and the unit stops.

⑳ **ENTER/MARK button**

Use this to confirm the selection of a setting item or to answer "YES" to a confirmation message.

Use to add marks manually during recording and playback.

Press when stopped at a mark location to delete that mark.

Press the ◀◀ or ▶▶I button while pressing and holding this button to move to the previous or next mark, respectively. When the Playback Control screen is open, use this button to set the IN (start) and OUT (end) points of the interval that you want to set for loop playback.

When the IN and OUT points are already set, press this button to cancel loop playback and clear the IN and OUT points.

㉑ **MIXER button**

Press this button to open the Mixer Screen.

When the Mixer Screen is open, press this button to return to the Home screen.

2 – Names and Functions of Parts

Front panel

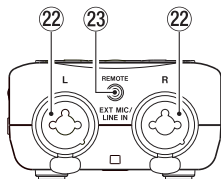

22 EXT MIC/LINE IN L/R jacks (XLR/TRS)

These are balanced analog XLR/TRS combo jacks for microphone and line level inputs.

XLR (1: GND, 2: HOT, 3: COLD)

TRS (Tip: HOT, Ring: COLD, Sleeve: GND)

CAUTION

- Confirm that phantom power is OFF before connecting a line level device to a **EXT MIC/LINE IN** jack. If you connect a line level device while phantom power is being supplied, that device and this unit could be damaged.
- Do not connect or disconnect mics with the **EXT MIC/LINE IN** jacks when the phantom power switch is set to ON. Doing so could cause a loud noise and might damage this unit and connected equipment.
- Set the phantom power switch to ON only when using a condenser microphone that requires phantom power. Turning phantom power on when a dynamic mic or other mic that does not require it is connected could damage this unit and connected equipment.
- When using condenser mics that require phantom power and dynamic mics together, be sure to use balanced dynamic mics. Unbalanced dynamic mics cannot be used when phantom power is enabled.
- Supplying phantom power to some ribbon mics will break them. If you are unsure, do not supply phantom power to a ribbon mic.

23 REMOTE jack ($\varnothing 2.5\text{mm TRS}$)

Connect a TASCAM RC-3F footswitch or TASCAM RC-10 wired remote control (both sold separately) here. This enables remote starting and stopping of playback and other functions.

Left side panel

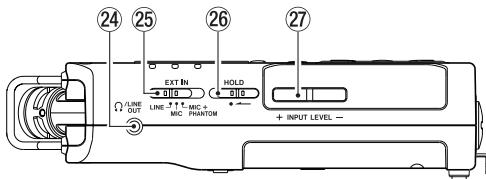

24 Ω /LINE OUT jack

Use this to connect with headphones or the line input jack of an amp or other equipment.

25 EXT IN switch

Use this to set the input type of the **EXT MIC/LINE IN** jacks and whether phantom power is on or off.

26 HOLD switch

Shift to the left end (in the direction of the arrow) to engage the hold function.

No buttons can be used when HOLD is active.

27 INPUT LEVEL (+/-) buttons

Use these to adjust the input level.

During adjustment, the input level setting status will be displayed in a pop-up window.

Right side panel

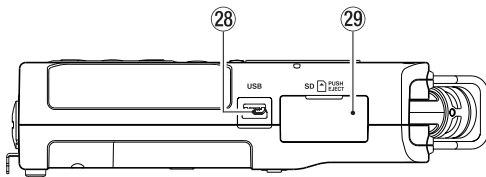

28 USB port

This is a Micro-B USB port.

Use a USB cable (A to Micro-B) to connect the unit to a computer. (See "12 – USB Connections" on page 65)

CAUTION

The unit should be connected directly to the computer, not through a USB hub.

29 SD card slot

Insert an SD card into this slot.

Bottom Panel

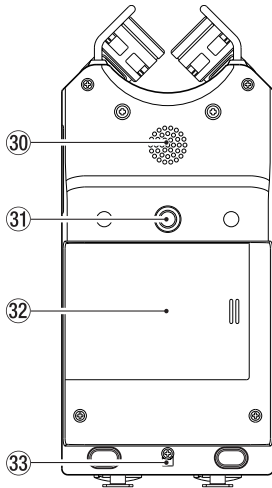

34 Battery compartment

Install batteries (3 AA) in this compartment to power the unit. (See "Using AA batteries" on page 16)

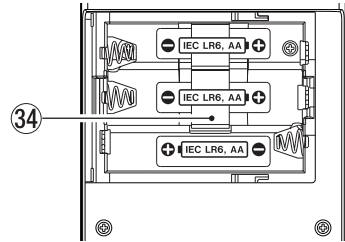

30 Built-in mono speaker

Use this built-in speaker to listen to recordings. The speaker will not produce sound in the following situations.

- When in recording standby
- When recording
- When in overdubbing mode
- When headphones are connected
- When the speaker output setting is off

31 Mounting thread for tripod or tilt foot (1/4-inch)

Use this to attach a tripod or the included tilt foot to the recorder.

CAUTION

- Ensure the tripod or microphone stand screws are securely fastened to prevent the unit from falling off.
- When attaching this unit to a tripod or microphone stand, be sure to place it on a level surface.

32 Battery compartment cover

When not using the included tilt foot, it can be stored by inserting it between the two protrusions on the inside of the battery compartment cover.

33 Hole for strap

Use this to attach a strap.

2 – Names and Functions of Parts

Home Screen

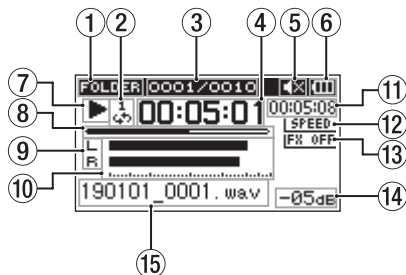

Home Screen when in ordinary operation mode

7 Recorder operation status

This icon shows the recorder operation status.

Indication	Explanation
■	Stopped
	Paused
▶	Playing back
▶▶	Searching forward
◀◀	Searching backward
▶▶	Skipping forward
◀◀	Skipping backward

8 Playback position display

The current playback position is shown by a bar. As playback progresses, the bar extends to the right.

9 Track status

The display changes according to the recording mode.

Indicators (examples)	Meaning
L R	Playing a file recorded in MONO or STEREO mode
LR -E	Playing a file recorded in dual recording mode
1/2 3/4	Playing a file recorded in 4-channel recording mode
1/2 1/2 INT/EXT	In OVERDUB SEPARATE mode
1-2 1-2 INT/EXT	During overdubbing (mix) mode

NOTE

When a track is soloed, its name appears highlighted **1-2**.

10 Level meters

The level of the input or playback sounds is shown. During OVER DUB (MIX), this shows the mixed level of the input and playback signals.

11 Remaining time

This shows the remaining time (hours: minutes: seconds) of the current file.

1 Playback speed status

One of the following icons appears according to the playback speed setting.

Indication	Playback speed
SPEED	×1.0
SPEED*	×1.1 – ×1.5
SPEED.	×0.5 – ×0.9
SPEED×	Playback speed not controllable

1 Playback area

This shows the current playback file area.

- ALL: All files in the MUSIC folder
- FOLDER: All files in the selected folder
- P. LIST: All files added to the playlist

2 Loop/repeat playback status

One of the following icons appears according to the playback speed setting.

- ⏮: Single playback
- ⏮🔄: Single file repeat playback
- 🔄: All file repeat playback
- 🔄🔄: Loop playback

3 Current playback file number/total number of files

This shows the current file number and total number of files in the current playback area.

4 Elapsed time

This shows the elapsed time (hours: minutes: seconds) of the current file.

5 Speaker output

- FX: Speaker output off
- FX: Speaker output on

6 Power supply status

A battery icon appears when power is supplied by batteries.

When batteries are being used, a battery icon shows the amount of power remaining in bars (||||| ||||| |||||).

The batteries are almost dead and the power will soon turn off (standby) if the ||||| icon with no bars appears.

When using a TASCAM PS-P520E AC adapter (sold separately) or USB bus power, ||||| appears.

NOTE

Sometimes a Battery Low warning appears when recording or conducting other demanding operations even when battery power remains.

13 Effect status

Shows whether the effect function is ON or OFF.

FX OFF: Built-in effect off

FX ON: Built-in effect on

14 Peak value in decibels (dB)

The maximum level that occurs in a fixed period of time is displayed digitally.

15 File name

This shows the name of the file playing back or its tag information.

ID3 tag information is shown when available for an MP3 file being played.

The project name is shown when multiple files have been recorded in 4-channel recording mode, dual recording mode or OVERDUB SEPARATE mode.

NOTE

ID3 tag information contains titles and artist names, which can be stored in MP3 files.

Recording screen

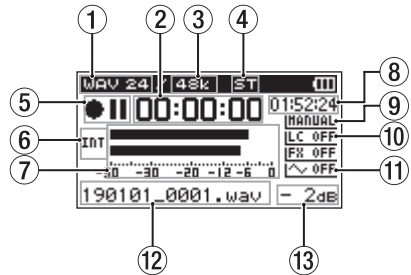

1 Recording format

This shows the file recording format.

WAV 16/WAV 24/BWF 16/BWF 24/MP3 320k/MP3 256k/MP3 192k/MP3 128k/MP3 96k/MP3 64k/MP3 32k

2 Elapsed recording time

The elapsed recording time of the file appears as hours: minutes: seconds.

3 Recording sampling frequency

This shows the file recording sampling frequency.

44.1K/48k/96k (Hz)

4 Number of recording channels

This shows the number of recording channels in the file.

ST, MONO

5 Recorder operation status







This icon shows the recorder operation status.

Indicator	Explanation
●	Recording standby or recording paused
REC	Recording
● PRE	Recording standby with the prerecording function on

2 – Names and Functions of Parts

⑥ Input source

This icon shows the input source.

Indicator examples	Meaning
	Input source set to built-in mics
	EXT MIC/LINE IN jack set as input source
	Second recording level setting (-6 - -12) when dual recording enabled
	When in OVERDUB SEPARATE mode, this shows that channels 1/2 are a playback file.
	When in OVERDUB MIX mode, this shows that the input source is set to a mix of the playback file and built-in mic signals
	Mix of playback file and EXT MIC/LINE IN set as input source in OVERDUB MIX mode

⑪ Tone output setting status

This icon shows whether the AUTO TONE function is on or off.

 OFF: AUTO TONE off

 ON: AUTO TONE on

⑫ File name

The file name that will automatically be given to the recorded file is shown.

The project name is shown when multiple files have been recorded in 4-channel recording mode, dual recording mode or OVERDUB SEPARATE mode.

⑬ Peak value in decibels (dB)

Peak input level values are shown in decibels.

NOTE

When a track is soloed, its name appears highlighted .

⑦ Level meters

The input signal levels are shown.

During overdub recording, the level of the combined input and playback sounds is shown.

⑧ Remaining recording time

The remaining recording time until the selected max file size is reached appears in hours: minutes: seconds. If the remaining recording time on the SD card is less, however, the remaining recording time on the card is shown.

⑨ Level mode setting status

This icon shows the level mode function setting.

 MANUAL: MANUAL

 LIMITER: LIMITER

 PEAK: PEAK REDUCTION

 AUTO: AUTO LEVEL

⑩ Low cut filter on/off status

This shows whether the low cut filter is on or off.

 LC OFF Low cut filter off

 LC 220 Low cut filter on (example: 220 Hz)

Menu item list

This list provides an overview of the various menu items. The menu items are as follows.

Menu item	Function	Pages	
REC SETTING	FORMAT	Set the recording format	see page 23
	SAMPLE	Set the sampling frequency	
	TRACK INC	Set the track incrementation function	see page 36
	LOW CUT	Set the low-cut filter	see page 37
	PRE REC	Set the pre-recording function	see page 37
	MODE	Set the auto-recording function mode	see page 35
	LEVEL	Set the auto-recording start level	
	AUTO TONE	Set tone output	see page 38
	TONE SECS	Set the length of the output tone	
	TONE VOL	Set the volume of tone output	
PLAY SETTING	AREA	Set the playback area	see page 44
	REPEAT	Set the repeat playback function	see page 48
	JUMP BACK	Set the jump back function	see page 51
	JUMP FWD	Set the jump forward function	see page 52
I/O SETTING	LEVEL MODE	Set the level mode function	see page 20
	SPEAKER	Turn the built-in speaker on/off	see page 50
	PLAY EQ	Set the playback equalization	see page 50
	LEVEL ALIGN	Set the output level alignment function	see page 50
BROWSE	Work with files and folders on the SD card	see page 41	
USB	SD CARD READER	Select the SD card reader mode	see page 65
	AUDIO I/F	Make USB audio interface settings	see page 66
OTHERS	INFORMATION	Information about the file, SD card, and system	see page 68
	TUNER	Use the tuner	see page 64
	EFFECT	Make effect settings	see page 61
	FILE NAME	Set the recording file name	see page 71
	DATE/TIME	Set the date and time used by the unit	see page 18
SYSTEM	REMOTE	Settings for the TASCAM RC-3F footswitch and TASCAM RC-10 wired remote control (both sold separately)	see page 72
	AUTO PWR SAVE	Set the automatic power saving function	see page 69
	BACKLIGHT	Set the backlight	see page 69
	CONTRAST	Adjust the display contrast	see page 69
	BATTERY TYPE	Set the type of batteries.	see page 69
	PHANTOM VOLT	Set the phantom power voltage.	see page 69
	LANGUAGE	Set the language shown on the display	see page 69
	INITIALIZE	Restoring the DR-40X to factory settings	see page 70
QUICK FORMAT	Format an SD card	see page 70	
ERASE FORMAT	Completely format an SD card	see page 70	

2 – Names and Functions of Parts

CAUTION

- When recording or in recording standby, only the following screens and items are shown.
LOW CUT and AUTO REC setting MODE and LEVEL items on the REC SETTING screen (AUTO REC settings are shown, but cannot be changed)
EFFECT screen REVERB, PRESET, LEVEL and SOURCE items
- When the Playback Control screen is open, pressing the **MENU** button will not open the MENU screen. This turns the loop playback function on/off. (See "Loop playback of a selection" on page 48)

Using the menu

We will explain this by showing how to set the playback area as an example.

1. Press the **MENU** button to open the MENU screen.

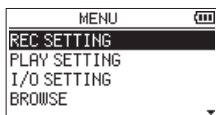

2. Use the + or – button to select a menu item (highlighted), and use the **ENTER/MARK** or **▶▶I** button to move to various settings screens.

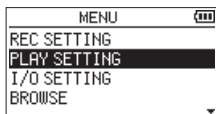

3. Use the + or – button to select (highlight) a menu item to set.

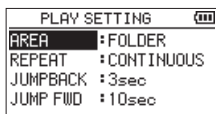

4. Use the **ENTER/MARK** or **▶▶I** button to move the cursor to highlight the value of the setting.

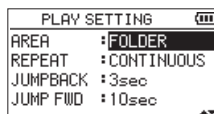

5. Use the + or – button to change the setting.
6. Press the **I◀◀** button to set a different item in the same menu.
This enables selection of a different item. Use the + or – button to select another item to set.
7. Repeat step 3 to 6 as necessary to set other items.
8. Press the **MENU** button to return to the MENU screen. To return to the Home screen, press the **⏪/I (HOME) [■]** button.

Basic operation

Use the following buttons to operate the various screens.

MENU button:

This opens the MENU screen.

PB CONT button:

This opens the Playback Control screen.

⏪/1 (HOME) [■] button:

When a settings screen is open, press the ⏪/1 (HOME) [■] button to return to the Home Screen. Use this to answer "NO" to a confirmation message.

ENTER/MARK button:

Use this to confirm the selection of a setting item or to answer "YES" to a confirmation message.

▶▶ button:

Use this to move the cursor (highlighted area) right on the screen and to open folders on the BROWSE screen.

◀◀ button:

Use this to move the cursor (highlighted area) left on the screen and to close folders on the BROWSE screen.

+ button:

Use this to move the cursor (the highlighted area) upward on the screen, or increase values.

- button:

Use this to move the cursor (highlighted area) down on the screen and to decrease values.

QUICK button:

This opens the Quick menu.

The content differs according to the recorder status and operation mode.

REC MODE button

Opens the REC MODE screen.

When the REC MODE screen is open, returns to the Home screen.

MIXER button

Opens the Mixer Screen.

When the Mixer Screen is open, returns to the Home screen.

1/2 [SOLO] button

Opens a meter display that shows the 1/2 input level setting status.

In DUAL or 4CH mode, press and hold during recording or playback to solo the channels.

Press when in OVERDUB (MIX) recording mode to mute the input sound.

3/4 [SOLO] button

Opens a meter display that shows the 3/4 input level setting status.

In DUAL or 4CH mode, press and hold during recording or playback to solo the channels.

Press the 3/4 [SOLO] button to switch between the input sound and the 3/4 track playback sound.

3 – Preparation

Powering the unit

This unit can operate on three AA batteries, using a TASCAM PS-P520E AC adapter (sold separately) or using a commercially-available USB cable (USB bus power).

Alkaline or Ni-MH batteries can be used.

To use USB bus power, see "Powering the unit with USB bus power" on page 65.

Using AA batteries

Open the battery compartment cover on the back of the unit. Fit three AA batteries to the ⊕ and ⊖ marks shown in the compartment, and close the battery compartment cover.

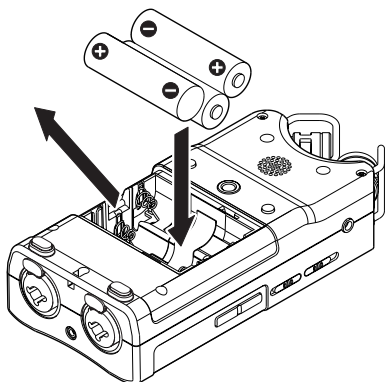

When using AA batteries, set the type of battery in order to accurately show the amount of power remaining and allow the unit to accurately determine whether power is available for proper operation. (See "Setting the battery type" on page 69)

CAUTION

- Do not use manganese dry cell batteries.
- This unit cannot recharge Ni-MH batteries. Use a commercially available recharger.
- The included alkaline batteries are for confirming operation of the unit and might not last very long.
- Before putting the bottom battery in, put the ribbon inside the compartment first. Failure to do so could make removing the batteries difficult.

NOTE

A great amount of power is required to provide phantom power to a condenser microphone. If you use a condenser microphone while running the unit on AA batteries (Ni-MH rechargeable or alkaline), the operation time will be greatly shortened because of their low capacities.

If you need to operate the unit for a long time, use the AC adapter (TASCAM PS-P520E) or using a commercially available USB cable (USB bus power).

Using an AC adapter (sold separately)

As shown in the illustration, connect a TASCAM PS-P520E AC adapter (sold separately) to the unit's USB port and charge the unit.

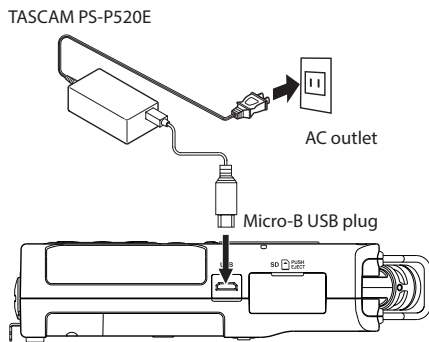

CAUTION

- Never use any adapter other than the designated PS-P520E AC adapter. Use of a different adapter could cause malfunction, fire or electric shock.
- Noise may occur when recording with a microphone if the unit is too close to the AC adapter. In such a case, keep sufficient distance between the AC adapter and the unit.

NOTE

When both batteries are installed and the AC adapter is connected, power will be supplied from the AC adapter.

Using USB bus power

Use the commercially-available USB cable to connect the unit and the computer as illustrated below.

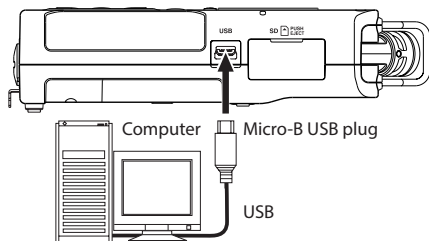

See "Powering the unit with USB bus power" on page 65.

Turning the power on and off (standby mode)

CAUTION

Do not wear connected headphones when turning the unit on or off (putting it in standby). Noise could damage the headphone driver unit or harm your hearing.

CAUTION

- The unit enters standby mode if turned off when the unit is operating on AC power supplied through a TASCAM PS-P520E AC adapter (sold separately) or bus power provided from a connected computer USB port.
- Turn down the volume of the monitoring system connected to the unit before turning the unit on or off (standby).

Turning the unit on

When the unit is off, press and hold the $\odot/|$ (HOME) [■] button until the TASCAM DR-40X start-up screen appears.

The Home Screen appears after the unit starts up.



Start-Up screen



Home screen

CAUTION

The first time a new unit is turned on after purchase, the following settings must be made.

- 1) A menu to change the menu screen display language will open.



Press the + or – button to move the cursor and select (highlight) the language to be shown on the display.

Options:

- English: use English
- 日本語: use Japanese
- Français: use French
- Español: use Spanish
- Deutsch: use German
- Italiano: use Italian
- Português: use Portuguese
- Русский: use Russian
- 中文: use Chinese
- 한글: use Korean

After selection, press the **ENTER/MARK** button to confirm.

You can also change the display language setting with the **SYSTEM** screen **LANGUAGE** item. (See "Setting the language" on page 69)

- 2) A screen for setting the built-in clock will open.

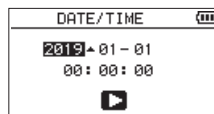

Press the **←** or **→** button to move the cursor (highlighted area), and use the + or – button to change values.

After completing the setting, press the **ENTER/MARK** button to confirm.

The start-up screen appears, followed by the Home Screen after start-up completes.

Date/time setting may be skipped by pressing the **ENTER/MARK** button. This setting can be made later. (See "Setting the date and time" on page 18.)

Turning the unit off (standby)

Press and hold the $\odot/|$ (HOME) [■] button until **LINEAR PCM RECORDER** appears on the display.

The unit turns off after it completes its shutdown process.



CAUTION

Always use the $\odot/|$ (HOME) [■] button to shutdown the unit.

While the unit is on, do not remove the batteries, disconnect the power cord when using a TASCAM PS-P520E AC adapter (sold separately) or disconnect the USB cable when using USB bus power. Doing so will cause all recordings, settings and other data to be lost. Lost data cannot be restored.

Resume function

The unit has resume function. When started up, the unit is located to the position (time) where it left off when shut down previously.

If the **PLAY** [▶] button is pressed after start-up, the file the unit was playing when shut down previously starts to be played from the position (time) where the unit left off when shut down.

NOTE

The required data are stored in the SD card. The resume function does not work if the card is exchanged or formatted.

3 – Preparation

Setting the date and time

This unit uses its internal clock to record the date and time to the recorded files.

1. Press the **MENU** button to open the MENU screen.

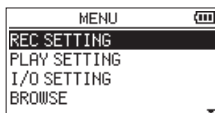

2. Use the + or – button to select the **OTHERS** menu item (highlighted), and press the **ENTER/MARK** or **▶▶** button.

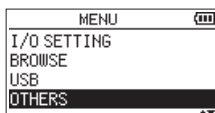

The **OTHERS** screen opens.

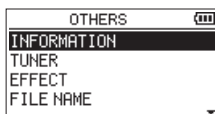

3. Use the + or – button to select the **DATE/TIME** menu item, and press the **ENTER/MARK** or **▶▶** button.

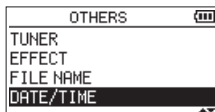

The **DATE/TIME** screen opens.

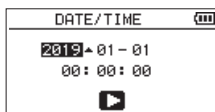

4. Use the **◀◀** and **▶▶** buttons to move the cursor, and use the + and – buttons to change the values.
5. Press the **ENTER/MARK** button to confirm the change and return to the **OTHERS** screen.

NOTE

The unit can automatically add the date and time set here to file names. (See "Setting the file name format" on page 71)

CAUTION

The date and time setting can be retained for only a few minutes when power is not supplied from batteries, a dedicated AC adapter (TASCAM PS-P520E; sold separately) or USB bus power.

When using batteries, we recommend replacing them before they are completely dead.

Inserting and removing SD cards

Inserting cards

1. Open the SD slot cover on the right side.
2. Insert the SD Card into the slot as shown in the following illustration until it clicks into place.

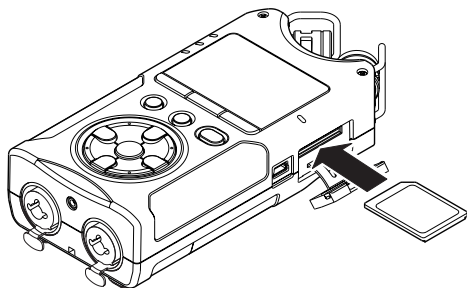

Removing the card

1. Open the SD slot cover.
2. Press the SD card in gently and then release it to allow it to come out.

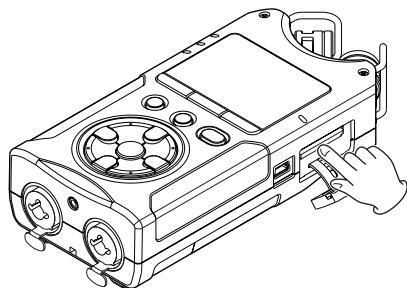

CAUTION

- Do not remove the SD card from the unit when it is connected to a computer by USB.
- SD cards that meet SD, SDHC or SDXC standards can be used with this unit.
- A list of SD cards that we have confirmed for use with this unit is available on the TEAC Global Site (<http://teac-global.com>).

Card write protection

SD cards have protect switches that prevent writing new data to them.

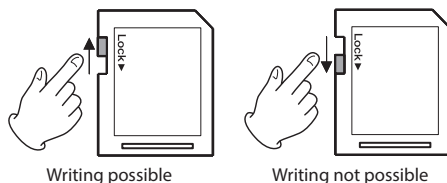

If you slide the protect switch to the "LOCK" position, file recording and editing is not possible. Move the switch to the unlocked position in order to record, erase and otherwise edit data on the card.

Preparing an SD card for use

In order to use an SD card in this unit, you must format it first.

1. Confirm that an SD card is installed and turn the power ON.
2. The following message appears when a new card or a card formatted for use with another device is installed in the unit.

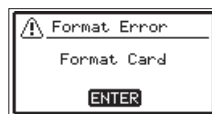

3. Press the **ENTER/MARK** button to start formatting.

CAUTION

Formatting an SD card erases all the data on it.

4. When formatting ends, the Home screen opens. You can also reformat the card in this unit at any time.

CAUTION

When formatting an SD card, the unit should be operating on AC power supplied through a TASCAM PS-P520E adapter (sold separately), USB bus power supplied from a connected computer, or batteries with sufficient remaining power.

3 – Preparation

Using the built-in speaker

To listen to the playback sound from the built-in speaker, turn on the **SPEAKER** item on the **I/O SETTING** screen.

NOTE

Even if **SPEAKER** is **ON**, the unit will not play through the speaker when the unit is recording, in recording standby or when headphones or an external speaker system is connected.

Operation from the MENU screen

1. Press the **MENU** button to open the **MENU** screen.
2. Use the + or – button to select (highlight) **I/O SETTING** and press the **ENTER/MARK** or **▶▶** button. The **I/O SETTING** screen will open.
3. Use the + or – button to select (highlight) the **SPEAKER** item and press the **ENTER/MARK** button.

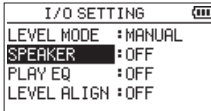

4. Use the + or – button to select **ON**.

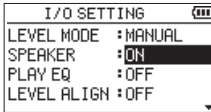

5. When finished, press the **⏪/I (HOME) [■]** button to return to the Home screen.

Operation from the Quick menu

1. During playback when the Home Screen is open, press the **QUICK** button to open the Quick menu.



2. Use the + or – button to select (highlight) **SPEAKER** and press the **ENTER/MARK** button. The **SPEAKER** screen will open.

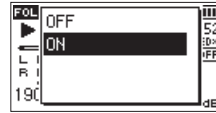

Options: OFF (default), ON

3. Use the + or – button to select (highlight) a function, and press the **ENTER/MARK** button to enable it and return to the Home Screen.

Connecting monitoring equipment

To listen with headphones, connect them to the **Ω /LINE OUT** jack.

To listen with an external monitoring system (powered monitor speakers or an amplifier and speakers), connect it to the **Ω /LINE OUT** jack.

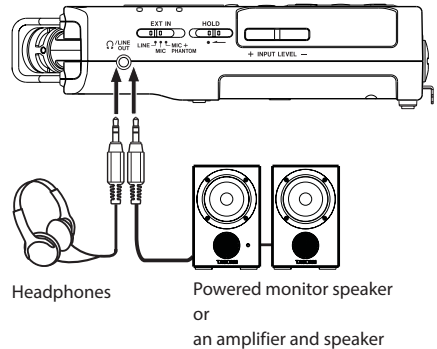

Using the built-in microphone

This unit's built-in microphones can be adjusted, allowing the angles of the microphones to be changed. You can choose clear stereo sound or wide stereo sound according to considerations including the recording source and situation by opening or closing the microphone pair.

Setting the mics to record a wide stereo sound (A-B position)

Open the mics to the left and right (A-B position). Set this way, the two microphones are spread wide to the left and right, enabling recording with a strong stereo field that is good for music, for example.

If you open or close the microphone pair while using the built-in stereo microphone and the left-right channels does not suit the angle of the microphone, a pop-up message appears to ask whether you want to swap the left-right channels of the microphone. (See "Microphone position detection" on page 22.)

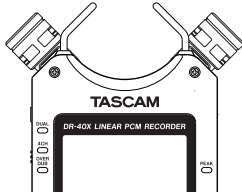

CAUTION

Set the left-right channels of the built-in microphone to L-R.

When using the built-in stereo microphone in an open state and the left-right setting is not L-R, **L-R** appears on the Home Screen. (See "Adding marks manually" on page 60)

Setting the mics to record a clear stereo sound (X-Y position)

Close the mics (X-Y position).

This setting enables recording with a clear stereo field and less phase difference.

If you open or close the microphone pair while using the built-in stereo microphone and the left-right setting does not suit the angle of the microphone, a pop-up message appears to ask whether you want to change the mic left-right setting. (See "Analog audio input and output ratings" on page 77)

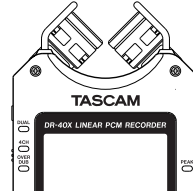

CAUTION

Set the built-in stereo mic setting to R-L.

When using the built-in stereo microphone in a closed state and the left-right setting is not R-L, **L-R** appears on the Home Screen. (See "Adding marks manually" on page 60)

3 – Preparation

Swapping the left-right channels of the built-in microphone pair

Swap the left and right mics according on the mic angle setting.

When the mic pair is open, the left mic should be set to the left channel and the right mic should be set to the right channel (L-R when in A-B position). When the mic pair is closed, the left mic should be set to the right channel and the right mic should be set to the left channel (R-L when in X-Y position).

If you are using the built-in microphone and this setting is not used, the current microphone setting icon appears as a warning on the Home screen.

1. Press the **RECORD** [●] button to start recording standby.
The **REC** indicator will blink and the recording screen will open.
2. Press the **QUICK** button.
The Quick menu will open.



3. Use the + or - button to select (highlight) **MIC LR SWAP**, and press the **ENTER/MARK** button.
The MIC LR swap screen will appear.

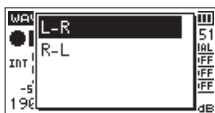

4. Use the + or - button to select (highlight) **L-R** or **R-L** according to the mic opening state.
5. Press the **ENTER/MARK** button to fix the setting, and to return to the Home screen.

Microphone position detection

The following pop-up message appears automatically whenever the built-in stereo mic is opened or closed and the left-right channel setting does not suit the mic angle.



Press the **ENTER/MARK** button to fix the setting, and to return to the Home screen.

Press the **⏪** (**HOME**) [■] button to leave the setting as it is.

NOTE

This screen appears automatically when the right mic is opened or closed. This screen will not appear when the left mic is opened or closed.

When you change the microphone angle setting and the pop-up message appears, you must press the **ENTER/MARK** button to change the L-R setting, press the **⏪** (**HOME**) [■] button to keep this setting as is, or restore the previous microphone angle to close the pop-up message before you can begin recording.

The pop-up message does not appear if you change the microphone position when recording. If necessary, press the **RECORD** [●] button to enter recording standby. Then, press the **QUICK** button and change the **MIC LR SWAP** setting. (See "Swapping the left-right channels of the built-in microphone pair" on page 22)

Attaching the tilt foot

When recording with the built-in mic, you can attach the included tilt foot to the tripod mounting threads to prevent the mic from being too low when placing the unit with the bottom side (battery compartment cover side) down. Attach it as shown below.

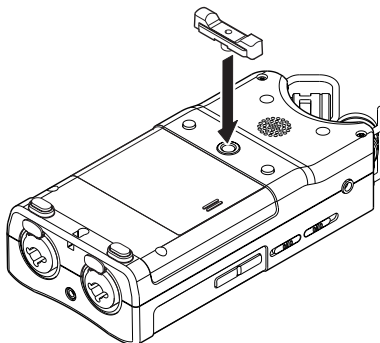

When not using the tilt foot, you can put it between the two protrusions on the inside of the battery compartment cover for storage and transportation.

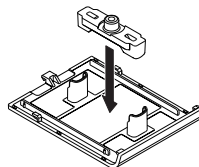

In addition to the built-in microphone, an external microphone or external audio device (i.e. CD player) can also be used for recording. You can select among MP3 (44.1/48 kHz, 32–320 kbps) and WAV/BWF (44.1/48/96 kHz, 16/24-bit) audio recording formats.

Marks added when recording or playing a WAV file that is BWF-compatible can be used with software that supports this format, for example.

This recorder has five recording modes. Using the overdubbing function, you can mix input signals with an audio file that is played back and record either the combined signals or just the input signal as a new file. With dual recording you can simultaneously record the same input signals at two different levels. You can also use external mics with the built-in mics for 4-channel recording.

Setting file format and sampling frequency (REC SETTING)

Select the audio file type that you want to record before you start recording.

1. Press the **MENU** button to open the **MENU** screen.
2. Use the + or – button to select **REC SETTING**, and press the **ENTER/MARK** or **▶▶I** button. The **REC SETTING** screen will open.

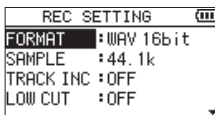

3. Use the + or – button to select **FORMAT**, and press the **ENTER/MARK** or **▶▶I** button.

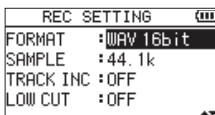

Set the file format here.

Use the + and – buttons to set it to one of the following options.

Options: BWF 16bit, BWF 24bit, WAV 16bit (default), WAV 24bit, MP3 32k (bps), MP3 64k, MP3 96k, MP3 128k, MP3 192k, MP3 256k, MP3 320k

NOTE

- BWF is a format created for broadcasting that has the same sound quality as the standard WAV format. It also uses the same “.wav” file extension as WAV files. In this manual, we distinguish these file types by using the terms BWF and WAV.
 - WAV/BWF formats provide better recording quality than MP3 formats.
 - MP3 formats enable longer recording times than WAV/BWF formats.
 - MP3 formats with higher values provide better recording quality.
4. Press the **I◀◀** button to enable selection of settings.
 5. Use the + or – button to select **SAMPLE**, and press the **ENTER/MARK** or **▶▶I** button.

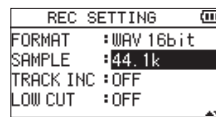

Set the sampling frequency.

Use the + or – button to select 44.1k (default), 48k or 96k.

NOTE

- 96k cannot be selected if **FORMAT** is set to **MP3**.
6. When finished, press the **⏪/I (HOME) [■]** button to return to the Home screen.

4 – Recording

Preparing the recording inputs

Recording with the built-in mics

Point the mics at the sound source and place the unit in a stable location where there is little vibration.

Recording with external mics (EXT MIC IN)

Connect external mics to the **EXT MIC/LINE IN** connectors. Point the mics at the sound source and place the unit in a stable location where there is little vibration.

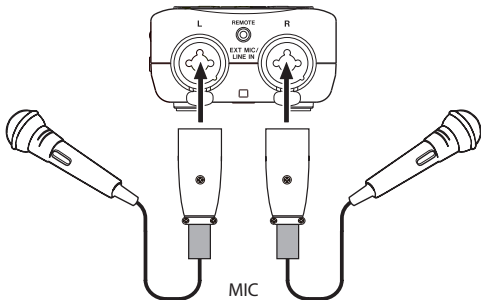

NOTE

The MIC LR SWAP setting is disabled when an external mic is being used.

Recording an external device (LINE IN)

Use stereo plug cables to connect to the output of an external audio device.

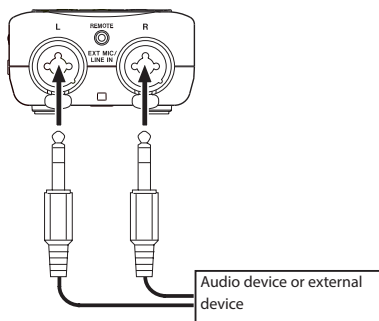

CAUTION

- If the input sound is still distorted after adjusting the input level of the unit, reduce the playback sound of the external device.
- If an external audio device with a fixed output line level is connected, it might not be possible to control the gain level of excessively loud input signals. In such cases, use the headphone jack or other level-controllable output for connection to the unit.

NOTE

The MIC LR SWAP setting is disabled when an external mic is being used.

Setting the external input type

When using an external input source, set the **EXT IN** switch on the left side panel according to the type of equipment connected.

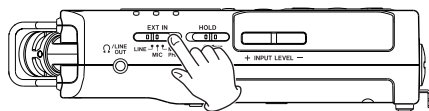

LINE

Set to **LINE** when connecting line output jacks of external devices to the analog inputs of this unit.

MIC

Set to **MIC** when connecting mics to the unit.

MIC+PHANTOM

Set to **MIC+PHANTOM** when connecting condenser mics that require phantom power (+24V or +48V) to the unit.

CAUTION

Depending on this setting, the input level setting range changes. For this reason, the input level might change greatly when this setting is changed. Before changing it, you should turn the unit off (standby) or turn the output level all the way down.

Using phantom power

When the **EXT IN** switch on the left side panel is set to **MIC+PHANTOM**, phantom power (+24V or +48V) is turned on and sent to the connected mics.

CAUTION

- Confirm that phantom power is OFF before connecting a line level device to a **EXT MIC/LINE IN** jack. If you connect a line level device while phantom power is being supplied, that device and this unit could be damaged.
- Do not connect or disconnect mics with the **EXT MIC/LINE IN** jacks when the phantom power switch is set to ON. Doing so could cause a loud noise and might damage this unit and connected equipment.
- Set the phantom power switch to ON only when using a condenser microphone that requires phantom power. Turning phantom power on when a dynamic mic or other mic that does not require it is connected could damage this unit and connected equipment.
- When using condenser mics that require phantom power and dynamic mics together, be sure to use balanced dynamic mics. Unbalanced dynamic mics cannot be used when phantom power is enabled.
- Supplying phantom power to some ribbon mics will break them. If you are unsure, do not supply phantom power to a ribbon mic.
- When using USB bus power, the unit might not be able to supply phantom power depending on the computer. In this case, use a TASCAM PS-P520E AC adapter (sold separately).
- Some condenser microphones will not operate when phantom power is set to +24V.
- Do not connect or disconnect the power cable connected to the **USB** port when using phantom power. Even when batteries are loaded in this unit, the power supply could be interrupted, resulting in the loss of or damage to data when recording.

Adjusting the input level

Input levels should be adjusted before starting recording to prevent recorded sounds and signals from being distorted by levels that are too high and from being so low that they are below the noise floor.

In addition to making manual adjustments, you can use the available limiter, automatic peak reduction and automatic level adjustment functions as you like.

TIP

In addition to adjusting the input levels, try changing the distance and angle between the microphone and the sound source. The angle and distance of the microphone can also change the character of the recorded sound.

Manually adjusting the input level

The input level can be adjusted.

To adjust the input level manually, the LEVEL MODE function must be set to **MANUAL**.

Setting the LEVEL MODE function on the MENU screen

1. Press the **MENU** button to open the MENU screen.
2. Use the + or – button to select (highlight) **I/O SETTING** and press the **ENTER/MARK** or **▶▶** button. The **I/O SETTING** screen will open.

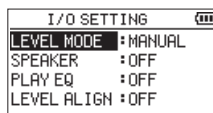

3. Use the + or – button to select (highlight) **LEVEL MODE**, and press the **ENTER/MARK** or **▶▶** button.

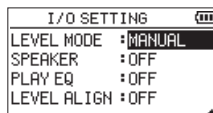

4. Use the + or – button to change the **LEVEL MODE** setting to **MANUAL**.
5. After completing the setting, press the **⏪** (**HOME**) [**■**] button to return to the Home Screen.

4 – Recording

Setting the LEVEL MODE function from the Quick menu

1. Press the **RECORD** [●] button to start recording standby.
The **REC** indicator will blink and the recording screen will open.
2. Press the **QUICK** button to open the quick menu.

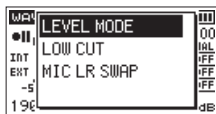

3. Use the + or – button to select (highlight) LEVEL MODE, and press the **ENTER/MARK** button.
This opens the LEVEL MODE setting screen.



4. Use the + or – button to change the LEVEL MODE setting to **MANUAL**.
5. Press the **ENTER/MARK** button to enable it and return to the Recording Screen.
The selected mode is shown with an icon in the recording screen.

Adjusting the input level

1. Press the **RECORD** [●] button to begin recording standby.
The **REC** indicator will blink and the recording screen will open.

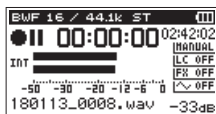

2. Adjust the input level using the **INPUT LEVEL** + or – button on the left side panel.

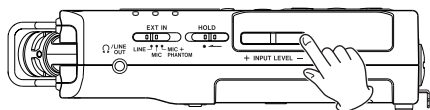

When you press the **INPUT LEVEL** + or – button on the left side of the unit, a pull-up with a meter showing the input level will appear at the bottom of the display.



The **PEAK** indicator to the right of the display lights red when the input level is too high.

Set the input level so that the indicator bars fluctuate centered on –12 without causing the **PEAK** indicator to light red when the loudest sounds occur.

NOTE

- The **INPUT LEVEL** setting pull-up menu that opens when you press an **INPUT LEVEL** (+/–) buttons on the left side of the unit will appear according to the input source. One of the following four labels will appear.

INT MIC LVL:	Built-in mic level
EXT IN LVL:	external input level
EXT Lch LVL:	external input left channel level
EXT Rch LVL:	external input right channel level

- When the input selection on the **REC. MODE** screen (**SOURCE** or **EHT IN**) is **EHT** only, use the following buttons to switch between **EHT Lch LVL** and **EHT Rch LVL**.

REC MODE	Button
STEREO	1/2 button
DUAL	
OVERDUB SEPARATE	3/4 button
4CH	
OVERDUB MIX	

- Press the **⏪/I (HOME)** [■] button to end recording standby.

- When in recording standby or recording, the speaker will not sound even if the **I/O** **SETTING** screen **SPEAKER** setting is **ON**.

Connect headphones to the **🔊/LINE OUT** jack if you want to adjust the level or record while monitoring the input.

Use the + or – button in the Home screen to adjust the monitoring volume. This does not affect the sound to be recorded.

Independent L/R channel EXT IN input level setting function

The **EXT IN** input levels can be set independently for the **L** and **R** channels.

Use this function when, for example, using two different mics or when volume differences are great.

1. Press the **REC MODE** button to open the **REC MODE** screen.
2. Use the + and – buttons to select (highlight) the **SOURCE** item (**EXT IN** when in **4CH** recording mode) and press the **ENTER/MARK** or **▶▶** button.
3. Use the + and – buttons to set the input source to **EXT INDEP.**



During stereo recording During 4CH recording

4. Press the **⏪ (HOME) [■]** button to return to the Home Screen
5. Press the **RECORD [●]** button to begin recording standby.
6. Press an **INPUT LEVEL (+/-)** button on the left side of the unit to open a pull-up with a meter showing the input level setting at the bottom of the display.



7. To set the input level for the other channel (L/R), press one of the following buttons.

REC MODE	Button
STEREO	1/2 button
DUAL	
OVERDUB SEPARATE	
4CH	3/4 button
OVERDUB/MIX	

NOTE

- If the input selection (**SOURCE** or **EXT IN**) on the **REC MODE** screen is set to **EXT IN 1/2**, the **EXT IN** input level setting will be the same for both **L** and **R**.
- If an effect is applied to the input sound when the **EFFECT** screen **SOURCE** item is set to **EXT IN** or the built-in mic, the effect sound will include elements from both the **L** and **R** channels, so sounds from the opposite channels will be mixed into the recording.

Using the LEVEL MODE function

Operation from the MENU screen

1. Press the **MENU** button to open the **MENU** screen.
2. Use the + or – button to select (highlight) **I/O SETTING** and press the **ENTER/MARK** or **▶▶** button. The **I/O SETTING** screen will open.
3. Use the + or – button to select (highlight) **LEVEL MODE**, and press the **ENTER/MARK** or **▶▶** button.

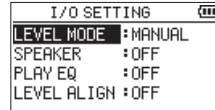

4. Use the + or – button to set the **LEVEL MODE** function.
Options: **MANUAL** (default), **LIMITER**, **PEAK REDUCTION**, **AUTO LEVEL**
5. After completing the setting, press the **⏪ (HOME) [■]** button to return to the Home Screen.

Operation from the Quick menu

1. Press the **RECORD [●]** button to begin recording standby. The **REC** indicator will blink and the recording screen will open.
2. Press the **QUICK** button. The Quick menu will open.

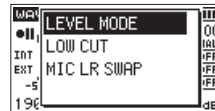

3. Select (highlight) **LEVEL MODE**, and press the **ENTER/MARK** button. This opens the **LEVEL MODE** setting screen.

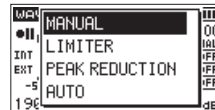

- Options:** **MANUAL** (default), **LIMITER**, **PEAK REDUCTION**, **AUTO LEVEL**

4 – Recording

- Use the + or – button to select (highlight) a mode, and press the **ENTER/MARK** button to enable the mode and return to the recording screen.
The selected mode is shown with an icon in the recording screen.

MANUAL

Manually adjusting the input level

LIMITER

This function prevents distortion when signals that are too loud are input suddenly.

This is also suited for recording live performances with large volume changes.

In this mode, the input level can be changed manually during recording.

CAUTION

Distortion could occur when the input sound is excessively loud even if the limiter function is on. In such a case, lower the input level or increase the distance between the unit and the source.

PEAK REDUCTION

If the input sound is too loud, the input level is automatically lowered to a suitable level. This function makes handling difficult input level settings easier. The input level can be raised manually if required.

TIP

Before recording a band performance, for example, you could test the PEAK REDUCTION function.

In recording standby, select the PEAK REDUCTION mode and maximize the input level. By conducting a rehearsal performance, the input gain will be reduced to an appropriate level for recording, setting an optimum input level for the performance.

This set input level can be used for recording by turning this mode off before starting recording. Otherwise, the input level will continue to be adjusted automatically in response to the input signal during recording.

AUTO LEVEL

Low input levels are raised and high input levels are lowered automatically, making this useful for recording meetings, for example. In this mode, the recording level cannot be changed manually.

Overview of recording modes

This recorder has five recording modes.

Set the recording mode with the REC MODE item on the REC MODE screen.

The settings available are different for each recording mode.

MONO mode

This is a mode for mono recording.

STEREO mode (default)

This is a mode for stereo recording of two independent left and right channels.

DUAL mode

This mode uses one input source to create two files with different input level settings (LEVEL MODE setting screen). Either two mono or two stereo recording files are created.

4CH mode

This mode uses both the built-in mics and the external inputs to record two pairs of inputs as two files.

Two stereo recording files are created.

OVERDUB mode

This recording mode add new sounds to the playback file.

The MIX setting mixes the playback and input sound to create a new file. The SEPARATE setting creates a new recording file with only the input sound.

When in OVERDUB mode, select one of these two options using the DUB MODE setting.

Recording (MONO/STEREO recording)

Make recording settings

- Press the **REC MODE** button to open the REC MODE screen.
- Use the + or – button to select REC MODE, and press the **ENTER/MARK** or ►► button.
- Use the + or – button to select MONO or STEREO. (Default: STEREO)



Mono Recording

Stereo Recording

- Press the ◀◀ button to enable selection of settings.
- Use the + and – buttons to select (highlight) SOURCE, and press the **ENTER/MARK** or ►► button.

6. Use the + and – buttons to set the input source.

REC MODE	SOURCE (options)	Explanation
MONO	INT MONO (default)	L/R signals of built-in mics are mixed and recorded in mono
	EXT IN 1	L external input is recorded in mono
STEREO	INT STEREO (default)	Built-in mics are recorded in stereo
	EXT IN 1/2	External inputs are recorded in stereo
	EXT INDEP.	Use two external input channels with independent level setting

7. Press the ◀◀ button to enable selection of settings.

8. If REC MODE is set to STEREO, you can also set MS decode.

When using MS mics, use the + and – buttons to select the MS DECODE item, and press the ENTER/MARK or ▶▶ button.

Use the + or – button to set MS DECODE to ON.

9. After completing the setting, press the ◀/1 (HOME) [■] button to return to the Home Screen.

Setting where files are saved

Set the folder where recorded files are saved. Recorded files will be saved in the currently selected folder. For details, see SELECT popup menu under "Folder operations" on page 43. If no setting is made, new recording files are created in the MUSIC folder.

Starting the recording

1. Press the RECORD [●] button to start recording standby.

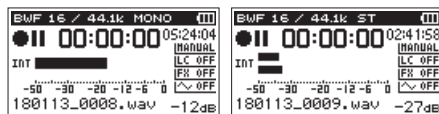

Mono Recording

Stereo Recording

The screen shows the recording file name, the input source, the recording audio file type and sampling frequency. Please confirm that these are as desired before starting recording.

2. To start recording, press the RECORD [●] button again. Normal recording starts.

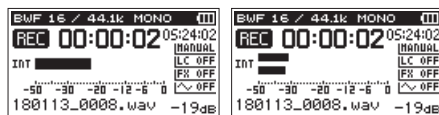

Mono Recording

Stereo Recording

When recording starts, the REC indicator lights continuously, and the display shows the elapsed recording time and the remaining recording time.

3. Press the ◀/1 (HOME) [■] button to end recording and create the audio file.

To pause recording, press the RECORD [●] button. Press the RECORD [●] button again to restart recording in the same file.

If you press the ◀/1 (HOME) [■] button after pausing a recorded audio file up to the moment that you paused recording is created.

CAUTION

Noise may occur when recording with a microphone if the unit is too close to the AC adapter. In such a case, keep sufficient distance between the AC adapter and the unit.

File names when recording in MONO/

STEREO 180113_0001.WAV

① ②

- ①: Set by the FILE NAME screen TYPE item
②: Recording file base number

Simultaneously recording two files at different input levels (DUAL REC)

This unit can simultaneously make two recordings at different input levels (dual recording). For example, when recording with mics, you can record the main recording with the input level set as high as possible while recording a backup recording with the input level set slightly lower to prevent the sound from distorting and record both at the same time. The main and backup recordings will each be saved as a separate file.

The input level setting will apply to the main recording (see "Preparing the recording inputs" on page 24 and "Adjusting the input level" on page 25).

Since the input level of the backup recording is set relative to the input level of the main recording, set the input level of the main recording first. Then, set the **DUAL LVL** item for the backup recording.

NOTE

Dual recording and overdubbing cannot be used simultaneously. In this mode, you cannot record the sound with the effect applied, but you can use the effect for monitoring.

Enabling dual recording

1. Press the **REC MODE** button to open the **REC MODE** screen.
2. Use the + or – button to select (highlight) **REC MODE**, and press the **ENTER/MARK** or **▶▶** button.
3. Use the + and – buttons to set it to **DUAL**.

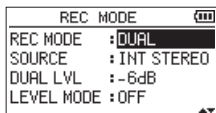

4. Press the **◀◀** button to return to setting item selection.
5. Use the + and – buttons to select (highlight) **SOURCE**, and press the **ENTER/MARK** or **▶▶** button.

6. Use the + and – buttons to set the input source.

SOURCE (options)	Explanation
INT STEREO (default)	Stereo recording with built-in mics
INT MONO	L/R signals of built-in mics are mixed and recorded in mono
EHT IN 1/2	Stereo recording with external mics or equipment
EHT INDEP.	Use two external input channels with independent level setting
EHT IN 1	Mono recording with external mics or equipment

7. Press the **◀◀** button to enable selection of settings.
8. Use the + and – buttons to select **DUAL LVL**, and press the **ENTER/MARK** or **▶▶** button.
9. Use the + and – buttons to set the dual level for the backup recording.
Setting range: -6dB (default value) to -12dB
10. Press the **◀◀** button to enable selection of settings.
11. Use the + or – button to select (highlight) **LEVEL MODE**, and press the **ENTER/MARK** or **▶▶** button.
12. Use the + or – button to set the backup recording **LEVEL MODE** function.

LEVEL MODE (options)	Meaning
OFF (default)	Dual level setting will be used.
LIMITER	This function prevents distortion when signals that are too loud are input suddenly. This is also suited for recording live performances with large volume changes.
PEAK REDUCTION	If the input sound is too loud, the input level is automatically lowered to a suitable level. This function makes handling difficult input level settings easier.
AUTO LEVEL	Low input levels are raised and high input levels are lowered automatically, making this useful for recording meetings, for example.

13. Press the **◀◀** button to enable selection of settings.

- When using MS mics, use the + and – buttons to select the **MS DECODE** item, and press the **ENTER/MARK** or **▶▶** button.
Use the + or – button to set **MS DECODE** to **0N**. (Default: **0FF**)
- After completing the setting, press the **⏪** (**HOME**) [**■**] button to return to the Home Screen.

Starting dual recording

- Press the **RECORD** [**●**] button to start dual recording. During dual recording, the recording screen appears as follows.

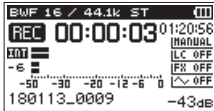

On the recording screen, the top meter shows the main recording input level and the bottom meter shows the backup recording input level.

Dual recording file names

Dual recording allows two files to be recorded simultaneously. The name of the backup recording file is the same as the name of the main recording file with “**D06**” added to it. The “**XX**” in “**DXX**” is according to the **DUAL LVL** setting value.

180113_0002S12.WAV

① ② ③ ④

180113_0002S34D06.WAV

① ② ③ ④ ⑤

- Set by the **FILE NAME** screen **TYPE** item
- Recording file base number
- “S” is the source file
- Assigned channels (“12” is channels 1/2 and “34” is channels 3/4)
- Dual level setting value (This would be “D06” if recorded at –6 dB or “D10” if recorded at –10dB, for example.)

CAUTION

- If the input level is less than –24 dB, dual recording might not have the expected result.
- When **LEVEL MODE** is set to **PEAK REDUCTION** or **AUTO LEVEL**, **DUAL LVL** cannot be changed.

Recording 3 or 4 channels

You can use the built-in mics and connect external mics or other equipment to record three or four channels. The recordings will be saved as two stereo files (channels 1/2 and channels 3/4).
If the **INT MIC**, **EXT IN L** channel and **EXT IN R** channel are different distances from their sound sources, you can set time delays for the **EXT IN L** and **EXT IN R** channels to compensate, using the **INT MIC** position as the baseline.

Making settings for 3/4-channel recording

- Press the **REC MODE** button to open the **REC MODE** screen.
- Use the + and – buttons to select **REC MODE**, and press the **ENTER/MARK** or **▶▶** button.
- Use the + and – buttons to set it to **4CH**.

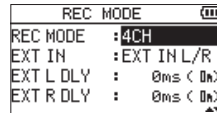

- Press the **◀◀** button to return to setting item selection.
- Use the + and – buttons to set the external input(s) used.

EXT IN (options)	Meaning
EHT IN 1/2 (default)	Use two external input channels as a stereo pair
EHT INDEP.	Use two external input channels with independent level setting
EHT IN 1	Use one external input channel (L)

NOTE

- If the **EHT IN** item is set to **EHT IN 1**, two stereo files will be created for it, but the **EXT IN R** channel will be silent.
- If the **EHT IN** item is set to **EHT IN 1** and you want the **EXT IN L** channel to be centered while monitoring, press the **MIXER** button and set the **3ch PAN** to **C** (center) when recording or in recording standby.

CAUTION

If the **EHT IN** item is set to **EHT IN 1**, the effect function will be disabled during recording.

4 – Recording

- Press the **◀◀** button to return to setting item selection.
- Use the + and – buttons to select (highlight) the **EXT L DLY** item, and press the **ENTER/MARK** or **▶▶** button.

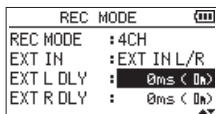

- Use the + and – buttons to set the delay time for the EXT L channel.

Range: -150ms (51m) - 0ms (0m) (default) - +150ms (51m)

- Press the **◀◀** button to highlight the item.
- Use the + and – buttons to select the **EXT R DLY** item and press the **ENTER/MARK** or **▶▶** button.
- Use the + and – buttons to set the delay time for the EXT R channel.
- Press the **◀◀** button to highlight the item.
- When using a mid-side mic, use the + and – buttons to select the **MS DECODE** item and press the **ENTER/MARK** or **▶▶** button.
Use the + or – button to set **MS DECODE** to **0H**.
- When finished, press the **⏏/I (HOME) [■]** button to return to the Home screen.

Starting 3/4-channel recording

Press the **RECORD [●]** button to begin recording standby.



NOTE

Before you start recording you can confirm the recording audio file format and sampling frequency at the top of the recording screen, as well as the input sources on the left and the recording project name beneath the meter bars.

Press the **RECORD [●]** button again to start recording.



File names when recording in 4-channel

4-channel recording creates two files simultaneously.

Two files – one for the built-in mics (channels 1/2) and one for the external mics or equipment (channels 3/4) – are created as a set.

180113_0003S12.WAV

① ② ③ ④

180113_0003S34.WAV

① ② ③ ④

- Set by the **FILE NAME** screen **TYPE** item
- Recording file base number
- “S” is the source file
- Assigned channels (“12” is channels 1/2 and “34” is channels 3/4)

Recording playback and input sounds together (overdubbing)

The overdubbing function has two modes. You can mix input signals with an already recorded file as it plays back and record either the combined signals or just the input signal as a new file, keeping the original recording as is.

NOTE

- The prerecording and automatic recording functions are disabled in overdubbing mode.
- In overdubbing mode, you cannot start new files manually by incrementing.
- Pausing is not possible in overdubbing mode (the **RECORD** [●] button is disabled).
- In overdubbing mode, the format and sampling frequency of the playback file will be used regardless of the recording format and sampling frequency settings.
- In overdubbing mode, you cannot use the MS decoder.
- If the playback file is a mono file, the recording file will also be mono.

CAUTION

Recording in **MIX** mode is not possible if the playback file format is 96kHz WAV/BWF or MP3 and there are two files (x appears before the beginning of the file name). Mix them down to one file before overdubbing. (See "Mixdown" on page 59)

If the playback file is mono, recording in **SEPARATE** Mode is not possible. Use **MIX** mode.

Setting the overdubbing mode

1. Press the **REC MODE** button to open the **REC MODE** screen.
2. Use the + or – button to select **REC MODE**, and press the **ENTER/MARK** or **▶▶I** button.
3. Use the + and – buttons to set it to **OVERDUB**.

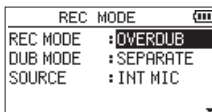

4. Press the **I◀◀** button to return to setting item selection.
5. Use the + and – buttons to select **DUB MODE**, and press the **ENTER/MARK** or **▶▶I** button.

6. Use the + and – buttons to set the overdubbing mode.

DUB MODE (options)	Explanation
SEPARATE (default)	The file on channels 1/2 is played back and a new file is recorded on channels 3/4. The playback signals of channels 1/2 are not recorded. The playback file will not be overwritten.
MIX	The playback signals of the files on channels 1/2 and 3/4 and the input signals are mixed and recorded as a new file. The playback file will not be overwritten.

NOTE

When a file is recorded using **SEPARATE** mode, the playback signal is not included in the recording, so you can record as many times you like with the same playback. Since a recording made in **SEPARATE** mode does not include the playback signal, you can record again with the same playback file as many times as you want. You can then listen to and select the best one from multiple recordings afterward.

7. Press the **I◀◀** button to return to setting item selection.
8. Use the + and – buttons to select (highlight) **SOURCE**, and press the **ENTER/MARK** or **▶▶I** button.
9. Use the + and – buttons to set the input source.

SOURCE (options)	Explanation
INT MIC (default)	Record using built-in mics.
EHT IN 1/2	Record using external inputs. When overdubbing a mono file (MIX mode), the input sound from the L external input is recorded.
EHT INDEP.	Use two external input channels with independent level setting
EHT IN 1	Record using external inputs. When overdubbing a stereo file (MIX mode), the same input sound is added to both 1/2 channels.

10. Press the **I◀◀** button to enable selection of settings.
11. After completing the setting, press the **⏪/I (HOME)** [■] button to return to the Home Screen.

4 – Recording

Select the file you want to overdub

Use the ◀◀ and ▶▶ buttons or the BROWSE screen to select the file that you want to overdub.

NOTE

See "5 – Working with Files and Folders (BROWSE screen)" on page 41 for selecting files using the BROWSE screen.

Conducting overdubbing

1. Press the **RECORD** [●] button to begin recording standby.



MIX recording

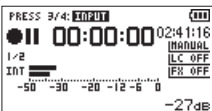

SEPARATE recording

When in MIX mode, press the **1/2 [SOLO]** button to mute monitoring of the input sound.

When in SEPARATE mode, if there are two playback files, press the **3/4 [SOLO]** button to switch between the input sound and the playback file. If there is only one input, this mutes the input sound.

2. Press the **RECORD** [●] button to start overdubbing. This starts overdubbing.



MIX recording

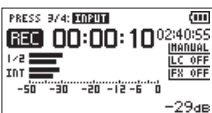

SEPARATE recording

When recording starts, the **REC** indicator lights and the display shows the elapsed and remaining recording times.

3. To stop recording, press the **⏏ (HOME)** [■] button.

File names when overdubbing

When overdubbing, file names are generated differently according to the **DUB MODE** setting.

SEPARATE mode

Playback file

180113_0004S12.WAV

File-A: ① ② ③ ④

The newly recorded file (recorded without the playback signal)

180113_0004S34.WAV

File-B: ① ② ③ ④

If you record again using the same playback file (File-A), the name of File-B above is changed to the file name below (File-C), and the new recording file is given the File-B file name.

180113_0004V34t1.WAV

File-C: ① ② ③ ④ ⑥

If you record one more time using the same playback file (File-A) (and File-B and File-C above are saved), the file name for File-B changes as shown below, with the number at ⑥ increased by one, and the new recording file given the File-B file name.

180113_0004V34t2.WAV

File-D: ① ② ③ ④ ⑥

MIX mode**Playback file****180113_0004S12.WAV**

File-A: ① ② ③ ④

The newly recorded file (recorded with the playback signal (File-A))**180113_0005S12.WAV**

File-E: ① ② ③ ④

If you record again using the same playback file (File-A), the file name of the new recording will be as follows.

180113_0006S12.WAV

File-F: ① ② ③ ④

In this mode, each time you record with the same playback file, the number in item ② increases by one for the name of each new file.

- ①: Set by the FILE NAME screen WORD item
- ②: Recording file base number
- ③: "S" is the source file and "V" is the virtual file
- ④: Assigned channels
("12" is channels 1/2 and "34" is channels 3/4)
- ⑥: Backup number in the virtual file

NOTE

In OVERDUB SEPARATE mode, the base number of the recording file and "S12" are added to the name of the playback file.

If writing files copied from elsewhere is not possible, enable writing using a computer, for example.

CAUTION

If you overdub record in separate mode a file recorded by this unit with dual recording, its file name will change and it will no longer be handled as a dual recording file. (See "Playback of files recorded using dual recording" on page 52)

Using the automatic recording function (AUTO REC)

This function starts and pauses recording, starts new files, and sets marks automatically according to the input signal level.

1. Press the **MENU** button to open the MENU screen.
2. Use the + or – button to select REC SETTING, and press the **ENTER/MARK** or **▶▶** button.
The REC SETTING screen will open.

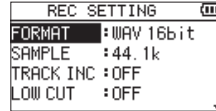

3. Use the + or – button to select the MODE and press the **ENTER/MARK** button or **▶▶** button.
4. Use the + and – buttons to set the automatic recording mode.

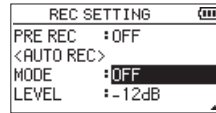

OFF (Default): Off

NEW FILE: Records and pauses automatically

MARK: Sets marks automatically during recording

5. Press the **◀◀** button to select the other item.
6. Use the + or – button to select LEVEL and press the **ENTER/MARK** button or **▶▶** button.

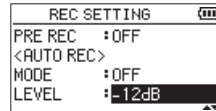

7. Use the + or – button to select the level that signal is judged to have been input when it exceeds this level. Set the value to one of the following selection.
-6dB/-12dB (default)/-24dB/-48dB
8. Press the **⏪** (**HOME**) [**■**] button to return to the Home screen.
9. Press the **RECORD** [**●**] button to begin recording standby.
Recording starts automatically when the input signal exceeds the LEVEL setting.

4 – Recording

- Recording operation changes according to the **MODE** setting.

NEW FILE mode

If the input signal level falls below the standard level set by **LEVEL** for more than five seconds, the unit enters recording standby. When the input signal level becomes higher than the standard level, the unit starts recording a new file.

MARK mode

If the input signal level falls below the standard level for more than five seconds, which is set on **LEVEL**, the unit adds marks when the input signal level becomes higher than the standard level again.

- Press the **⏪/I (HOME) [■]** button to stop automatic recording.

TIP

By using this in combination with the **PRE REC** function, you can record events without losing the beginnings of sounds.

CAUTION

- The automatic recording function cannot be used during overdub or overwrite recording.
- When the auto-recording function is on, the self-timer cannot be used. Since automatic recording cannot be used in overdubbing mode, however, the self timer can be used even if the automatic recording function is set to on.

Continuing to record in a new file (track incrementing)

You can manually or automatically split a recording by creating a new file. (Track increment)

Manually incrementing files during recording

You can manually split a recording by creating a new file.

- Press the **▶▶I** button while recording.

NOTE

When new files are created, incremental numbers are added to the end of each project name.

CAUTION

- A new file cannot be created if the total number of files and folders would exceed 5000.
- Files shorter than two seconds cannot be created. If the sampling frequency is 96 kHz, files shorter than four seconds cannot be created.
- If the name of a newly created file would be the same as that of an existing file, the number will be incremented until the new file has a unique name.
- The track incrementing function cannot be used during overdub or overwrite recording.

Automatically incrementing files by a set time

Without pausing recording, a new file can be created automatically during recording when the time set on the **TRACK INC** screen is reached.

Follow these procedures to set the amount of time that triggers track incrementation.

- Press the **MENU** button to open the **MENU** screen.
- Use the **+ or –** button to select **REC SETTING**, and press the **ENTER/MARK** or **▶▶I** button. The **REC SETTING** screen will open.
- Use the **+ or –** button to select **TRACK INC** item, and press the **ENTER/MARK** or **▶▶I** button.

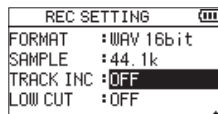

Use the **+ and –** buttons to set the automatic track time. Options: **OFF** (default), **5min**, **10min**, **15min**, **30min**, **60min**

- After completing the setting, press the **⏪/I (HOME) [■]** button to return to the Home Screen.

CAUTION

A new file cannot be created if the total number of files and folders would exceed 5000.

Using the low-cut filter

The low cut filter can reduce noise such as offensive wind noise from air-conditioners and projectors.

Operation from the MENU screen

1. Press the **MENU** button to open the MENU screen.
2. Use the + or – button to select **REC SETTING**, and press the **ENTER/MARK** or **▶▶▶** button. The **REC SETTING** screen will open.
3. Use the + or – button to select **LOW CUT**, and press the **ENTER/MARK** or **▶▶▶** button.

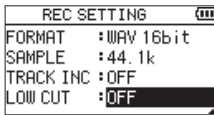

4. Use the + or – button to select the cut off frequency of the low cut filter for mic input.

Options: OFF (default), 40Hz, 80Hz, 120Hz

5. After completing the setting, press the **⏪/I (HOME)** button to return to the Home Screen.

Operation from the Quick menu

1. Press the **RECORD** button to begin recording standby. The **REC** indicator will blink and the recording screen will open.
2. Press the **QUICK** button. The Quick menu will open.

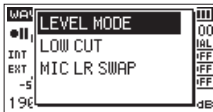

3. Use the + or – button to select (highlight) **LOW CUT** and press the **ENTER/MARK** button. The **LOW CUT** setting screen will open.

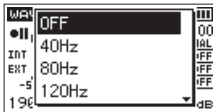

Options: OFF (default), 40Hz, 80Hz, 120Hz, 220Hz

4. Use the + or – button to select (highlight) a mode, and press the **ENTER/MARK** button to enable the mode and return to the recording screen. The selected mode is shown with an icon in the recording screen.

Capturing a few seconds before starting recording (PRE REC)

When the unit is in recording standby, the prerecording function can record up to two seconds of signal input before recording is started.

1. Press the **MENU** button to open the MENU screen.
2. Use the + or – button to select **REC SETTING**, and press the **ENTER/MARK** or **▶▶▶** button. The **REC SETTING** screen will open.
3. Use the + or – button to select **PRE REC**, and press the **ENTER/MARK** or **▶▶▶** button.
4. Use the + or – button to select **ON**. (Default: OFF)

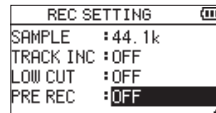

5. After completing the setting, press the **⏪/I (HOME)** button to return to the Home Screen.

TIP

By using this in combination with the **AUTO REC** function, you can record events without losing the beginnings of sounds.

NOTE

- If you start recording within two seconds from when the record standby mode is turned ON, recording will begin from the moment of record standby.
- The pre-recording function is disabled during overdub or overwrite recording.

4 – Recording

Using tone output

The tone output function can be used to automatically insert a tone signal whenever recording starts and stops.

By connecting the  LINE OUT jack on the left side of the unit and the external mic input jack of a video camera or digital camera capable of recording video and using the AUTO TONE function, the same tone signal can be recorded to files on both units. These tones can be used as guides when synchronizing the files in video editing software.

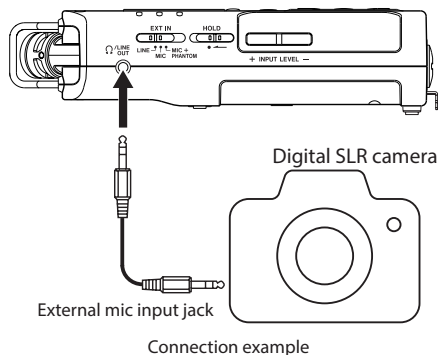

Setting the AUTO TONE function

1. Press the **MENU** button to open the MENU screen.
2. Use the + and – buttons to select the **REC SETTING** menu and press the **ENTER/MARK** or **▶▶** button. The **REC SETTING** screen will open.
3. Use the + and – buttons to select (highlight) **AUTO TONE**, and press the **ENTER/MARK** or **▶▶** button.
4. Use the + and – buttons to set when tone signals are inserted.

Options: OFF (default), HEAD (recording start only), HEAD+TAIL (recording start and stop)

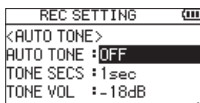

5. After completing the setting, press the **⏪/I (HOME)** button to return to the Home Screen.

NOTE

When tone output is on,  will appear on the Recording Screen.

CAUTION

When recording is stopped by the AUTO REC function, no tone signal will be recorded when it stops.

Setting the AUTO TONE length

You can set the length of the AUTO TONE.

1. Press the **MENU** button to open the MENU screen.
2. Use the + and – buttons to select the **REC SETTING** menu and press the **ENTER/MARK** or **▶▶** button. The **REC SETTING** screen will open.
3. Use the + and – buttons to select **TONE SECS** and press the **ENTER/MARK** or **▶▶** button.
4. Use the + and – buttons to set the tone length.

Options: 0.5SEC., 1SEC. (default), 2SEC., 3SEC.

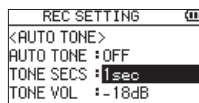

5. After completing the setting, press the **⏪/I (HOME)** button to return to the Home Screen.

Adjusting the AUTO TONE volume

You can adjust the volume of the AUTO TONE.

1. Press the **MENU** button to open the MENU screen.
2. Use the + and – buttons to select the **REC SETTING** menu and press the **ENTER/MARK** or **▶▶** button. The **REC SETTING** screen will open.
3. Use the + and – buttons to select **TONE VOL** and press the **ENTER/MARK** or **▶▶** button.
4. Use the + and – buttons to adjust the tone volume.



Options: -12dB, -18dB (default), -24dB, -30dB, -36dB



5. After completing the setting, press the **⏪/I (HOME)** button to return to the Home Screen.

Self-timer function

Similar to a camera, the DR-40X has a self-timer function to begin recording after a set period of time.

1. Press **RECORD** [●] button when stopped or playing to put the unit in recording standby, and press the **PB CONT** button.
2. The self-timer icon  appears in the recorder status screen, and time is shown on the right. Each time you press the **PB CONT** button, the setting changes as follows:
 Time shown to right of icon
 OFF (default) → 5S (5 seconds) → 10S (10 seconds) → OFF

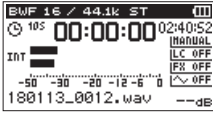

3. Set the time period, and press the **RECORD** [●] or **PLAY** [▶] button. Recording will start after the set time period.

NOTE

- This function cannot be used when recording is paused in the middle of recording.
- Self-timer function is not possible when using the AUTO REC function.
- During overwrite recording, the self-timer cannot be used.

Solo function

Press and hold the **1/2 [SOLO]** or **3/4 [SOLO]** button to enable the solo function.

Use this in 4-channel mode and other cases when multiple inputs are being recorded to monitor only one of the inputs. You can check the solo status with the input source icons.

4 – Recording

Recording duration

The table below shows the maximum recording time on SD/SDHC/SDXC cards of different capacities for different file formats for recording.

File format (recording setting)		SD/SDHC/SDXC card capacity (hours: minutes)				
		1GB	2GB	4GB	8GB	
WAV/BWF 16-bit (stereo)	44.1 kHz	1:41	3:22	6:44	13:28	
	48kHz	1:33	3:06	6:12	12:24	
	96kHz	0:46	1:33	3:06	6:12	
WAV/BWF 24-bit (stereo)	44.1 kHz	1:07	2:15	4:30	9:00	
	48kHz	1:02	2:04	4:08	8:16	
	96kHz	0:31	1:02	2:04	4:08	
MP3 (stereo/mono)	32kbps	44.1 kHz/48 kHz	74:32	149:04	298:08	596:16
	64 kbps	44.1 kHz/48 kHz	37:16	72:32	149:04	298:08
	96 kbps	44.1 kHz/48 kHz	24:50	49:40	99:20	198:40
	128 kbps	44.1 kHz/48 kHz	18:38	37:16	74:32	149:04
	192 kbps	44.1 kHz/48 kHz	12:25	24:50	49:40	99:20
	256 kbps	44.1 kHz/48 kHz	9:19	18:37	37:16	74:32
	320 kbps	44.1 kHz/48 kHz	7:27	14:54	29:48	59:36

- The recording times shown above are estimates. They might differ depending on the SD/SDHC/SDXC card in use.
- The recording times shown above are not continuous recording times, but rather they are the total possible recording times for the SD/SDHC/SDXC card.
- If the recording time exceeds 24 hours, a new file will be created automatically and recording will continue without pause.
- If recorded in mono in WAV files, the maximum recording time will be double the figures above.
- For dual and 4-channel recording in WAV/BWF format, the recording times are about half those shown above.

5 – Working with Files and Folders (BROWSE screen)

On the BROWSE screen, you can view the contents of the **MUSIC** folder, which contains audio files, on the SD card. On this screen, you can also play and erase selected audio files, create folders, add files to the playlist and so on. (See "Using the playlist" on page 46.)

TIP

If you connect the unit with a computer by USB or mount the SD card on a computer using a card reader or other input, you can use the computer to change the folder structure within the **MUSIC** folder and erase files as you would the contents of a hard drive. Furthermore, you can change file names from the computer.

To open the BROWSE screen, press the **MENU** button to open the **MENU** screen. Use the + or – button to select **BROWSE** and press the **ENTER/MARK** or **▶▶** button.

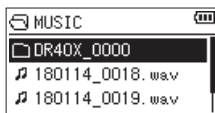

The content of the folder that contains the file that was selected on the Home Screen before the BROWSE screen was opened appears on the display.

Screen navigation

On the BROWSE screen, folders and music files appear in a hierarchical structure much like they would appear on a computer. Only two levels of folders can be created.

- Use the + and – buttons to select files and folders.
- When a folder is selected (highlighted), press the **▶▶** button to show the contents of that folder.
- When a file or folder is selected (highlighted), press the **◀◀** button to exit the currently open folder and go to a higher level in the folder structure.
- When a file or folder is selected (highlighted), press the **QUICK** button to open a pop-up menu.
- When a file is selected (highlighted), press the **▶▶** button to select that file and return to the Home Screen.
This folder that contains this file becomes the current folder, and new recorded file will be saved in this folder. If the playback area has been set to **FOLDER**, this folder becomes the playback area.
- When a file is selected (highlighted), press the **ENTER/MARK** button to start playback and return to the Home Screen.
- When a folder is selected, press the **ENTER/MARK** button to return to the Home screen. The first file in the folder (shown at the top of the file list) will be played.

This folder becomes the current folder, and new recorded files will be saved in this folder. Regardless of the previous setting, the playback area is set to **FOLDER**, and this folder becomes the new playback area.

Icons on the BROWSE screen

The meanings of icons that appear on the BROWSE screen are as follows.

📁 Root Music Folder

The **MUSIC** Folder is the highest (root) level folder in the hierarchy shown on the BROWSE screen.

🎵 Audio file

The **🎵** icon appears before the names of music files.

⊕ Plus folder

This is a folder that contains subfolders.

□ Plain folder

This is a folder that does not contain subfolders.

📂 Open folder

The contents of the folder marked with this icon currently appear on this screen.

File operations

Select (highlight) the desired audio file on the BROWSE screen and press the **QUICK** button to open the pop-up window that is shown below.



Use the + or – button to select an item, and press the **ENTER/MARK** button to cause the unit to work as follows.

INFORMATION

Information (date/time, size) about the selected file appears. Press the **ENTER/MARK** button again or press the **⏪** (**HOME**) [**■**] button to return to the BROWSE screen.



5 – Working with Files and Folders (BROWSE screen)

ADD PLAYLIST

Add the selected file to the playlist. (See "Using the playlist" on page 46)

FILE SWAP

Files recorded during the following recording modes can be swapped.

4CH mode:

A file recorded by the built-in mics (channels 1/2) can be swapped with a file recorded by external mics or equipment (channels 3/4).

Examples

180113_0002S12.WAV



180113_0002S34.WAV

180113_0002S34.WAV



180113_0002S12.WAV

OVERDUB SEPARATE mode:

- ① The playback file and a newly recorded file can be swapped.

Examples

180113_0004S12.WAV



180113_0004S34.WAV

180113_0004S34.WAV



180113_0004S12.WAV

The above is the same as swapping File-A and File-B as described on 34 page .

- ② The newly recorded file and the virtual file saved based on it can be swapped.

Examples

180113_0004S34.WAV



180113_0004V34t1.WAV

180113_0004V34t1.WAV



180113_0004S34.WAV

The above is the same as swapping File-B and File-C as described on page 34. In addition, since you can choose the virtual file freely when swapping the above, you can also swap File-B and File-D as on page 34.

However, you cannot swap two virtual files (for example, File-C and File-D as on page 34).

FILE DELETE

A message appears to confirm that you want to delete the file.

Press the **ENTER/MARK** button to delete the file and the **⏪/I (HOME) [■]** button to cancel deletion.



PROJECT DELETE

A pop-up message appears confirming that you want to erase the project containing the selected file.

Press the **ENTER/MARK** button for each project to erase. Press the **⏪/I (HOME) [■]** button to cancel deletion.



CAUTION

This deletes all the files in the selected project.

Folder operations

Select (highlight) the desired folder on the BROWSE screen and press the **QUICK** button to open the following pop-up window.



Use the + or – button to select an item, and press the **ENTER/MARK** button to cause the unit to execute that operation as follows.

SELECT

Selects the first file in the folder and returns to the Home Screen. Regardless of the previous setting, the playback area is set to **FOLDER**, and this folder becomes the new playback area. When recording, files are created in this folder.

ALL DELETE

A pop-up message appears to confirm that you want to delete all the files in the selected folder at once. Press the **ENTER/MARK** button to delete the file and the **⏪/1 (HOME) [■]** button to cancel deletion.



NOTE

You cannot erase read-only files and files that are not recognized by this unit.

FOLDER DELETE

A pop-up message appears to confirm that you want to delete the selected folder. Press the **ENTER/MARK** button to delete the folder or press the **⏪/1 (HOME) [■]** button to cancel deletion.



NOTE

You cannot erase folders than contain read-only files and files that are not recognized by this unit.

Creating a new folder

NEW FOLDER appears at the bottom of each folder list.

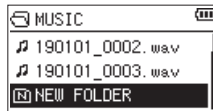

Select (highlight) **NEW FOLDER**, and press the **ENTER/MARK** or **▶▶1** button. A pop-up appears to confirm that you want to create a new folder.



Press the **ENTER/MARK** button to create a new folder or press the **⏪/1 (HOME) [■]** button to cancel. Since this unit supports only a two-level folder structure, the **NEW FOLDER** function is not available in second-level folders. A newly created folder becomes the current folder (currently selected folder), and recorded files are saved in this folder. If the playback area has been set to **FOLDER**, this folder becomes the playback area.

6 – Playback

On the Home screen, you can use the ◀◀ and ▶▶ buttons to select the playback file. The files that you can select are determined by the playback area setting. Limiting the playback area makes file selection easier when you have numerous recorded and copied files on the SD card.

On the PLAY SETTING screen, you can select all files, the current folder or the playlist as the playback area. You can also use the BROWSE screen to set a folder as the playback area.

NOTE

On the BROWSE screen, regardless of the playback area setting, you can select any file on the card that you want.

Adjusting the playback volume

The volume of output through the built-in speaker or the ◻/LINE OUT connector can be adjusted using the + or – button while the Home screen is shown.

A pull-up volume indicator appears.



Setting the playback area (AREA)

Set the playback area for repeat and ordinary playback on the PLAY SETTING screen.

1. Press the **MENU** button to open the MENU screen.
2. Use the + or – button to select **PLAY SETTING**, and press the **ENTER/MARK** or ▶▶ button.
This opens the **PLAY SETTING** screen.

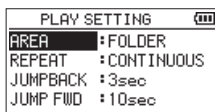

3. Use the + or – button to select (highlight) **AREA**, and press the **ENTER/MARK** or ▶▶ button.

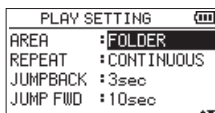

4. Use the + or – button to set the playback area.

ALL FILES

Set the playback area as all files in the music folder on the SD card.

FOLDER (default)

Set the playback area as all the files in the currently selected folder.

PLAYLIST

Set the playback area as the files in the playlist. (See "Adding marks manually" on page 60)

If there is no playlist defined, a No PLAYLIST pop-up appears.



5. After completing the setting, press the ◻/I (**HOME**) [■] button to return to the Home Screen.

NOTE

The current playback area setting appears in the upper left of the Home screen.

Playback area indication



Selecting a folder for the playback area (1)

Regardless of the current playback area, if you select a folder on the BROWSE screen, the playback area changes to the selected folder.

1. Press the **MENU** button to open the MENU screen.
2. Use the + or – button to select BROWSE, and press the **ENTER/MARK** or **▶▶** button.
The BROWSE screen will open.

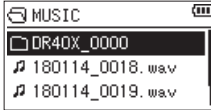

The content of the folder that contains the file selected on the Home Screen is displayed.

3. Use the **◀◀** or **▶▶** button to select a folder level, and use the + or – button to select a folder.
For an explanation of how to use the BROWSE screen, see "Screen navigation" on page 41.
4. Press the **QUICK** button to open the following pop-up window.



Use the + or – button to select SELECT, and press the **ENTER/MARK** button.

The display returns to the Home screen. The first file in the folder is selected, and the unit is stopped.

Regardless of the previous setting, the playback area is set to FOLDER, and this folder becomes the playback area. This folder becomes the current folder, and new recorded files will be saved in this folder.

Selecting a folder for the playback area (2)

When the playback area is set to FOLDER, if you select a file on the BROWSE screen, the folder that contains the selected file becomes the playback area.

1. Press the **MENU** button to open the MENU screen.
2. Use the + or – button to select BROWSE, and press the **ENTER/MARK** or **▶▶** button.
The BROWSE screen will open.

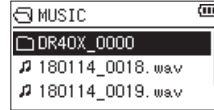

A file list of the folder that contains the file selected in the Home screen is displayed. Use the **◀◀** or **▶▶** button to change folder level, and use the + and – buttons to select (highlight) the folder that contains the file you want to play.

For an explanation of how to use the BROWSE screen, see "Screen navigation" on page 41.

3. Press the **▶▶** button.
4. The display returns to the Home screen, and the selected file starts playing.

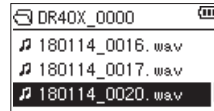

5. Press the **ENTER/MARK** or **▶▶** button.
The display returns to the Home screen, and the selected file starts playing. This folder becomes the current folder, and new recorded files will be saved in this folder.
If the playback area is set to FOLDER, the folder that contains the selected file becomes the playback area.

6 – Playback

Using the playlist

You can make a list of files for playback (playlist). On the **PLAY SETTING** screen if you select **PLAYLIST** for the **AREA** item, you can set playback to just the files in the playlist.

Adding files to the playlist

1. Press the **MENU** button to open the **MENU** screen.
2. Use the + or – button to select (highlight) **BROWSE**, and press the **ENTER/MARK** or **▶▶** button. The **BROWSE** screen will open.

NOTE

For an explanation of how to use the **BROWSE** screen, see "5 – Working with Files and Folders (**BROWSE** screen)" on page 41.

3. Use the + or – button to select the file you want to add to the playlist, and press the **QUICK** button. A pop-up window appears.

NOTE

For details about how to select the file, see "File operations" on page 41.

4. Use the + or – button to select (highlight) **ADD LIST**.



5. Press the **ENTER/MARK** button. The file is added to the playlist and the popup window closes.
6. Repeat steps 3, 4, and 5 as necessary to add more files to the playlist. The files are numbered in the order that they are added.

Editing the playlist

You can view and edit the playlist you have made on the **PLAYLIST** screen. You can also use this screen to play tracks and to edit the playlist.

1. Press the **MENU** button to open the **MENU** screen.
2. Use the + or – button to select **BROWSE**, and press the **ENTER/MARK** or **▶▶** button. The **BROWSE** screen will open.
3. Use the **◀◀** button to move to the top folder level.



4. Use the + or – button to select **PLAYLIST**, and press the **▶▶** button. This opens the **PLAYLIST** screen.



5. Use the + or – button to select the file you want to edit, and press the **QUICK** button. A pop-up window appears.



6. Use the + and– buttons to select an item, and press the **ENTER/MARK** button to cause the unit to execute that operation as follows.

MOVE

Select this to change the order of files in the playlist. In addition to the file name, the file number also appears highlighted in inverse.

- Use the + or – button to move the selected track to a different position in the playlist.

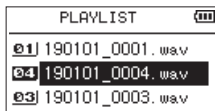

In the above example, the 4th file has been moved to the 3rd file position.

- Press the **ENTER/MARK** button. This completes movement and reopens the **PLAYLIST** screen.

DELETE(Remove)

Remove the selected file from the playlist. The file is removed from the playlist, but it is not erased from the SD card.

ALL CLR

This clears all files from the playlist.

NOTE

This clears files from the playlist but does not erase them from the SD card.

Selecting files for playback (skipping)

When the Home Screen is open, use the **I◀◀** and **▶▶I** buttons to select the file for playback.

If you press the **I◀◀** button when the playback position is located at the middle of a file, it will return to the beginning of that file. If you press the **I◀◀** button when located at the beginning of a file, the playback position will skip to the beginning of the previous file.

If you press the **▶▶I** button when located at the beginning of or middle of a file, the playback position will skip to the beginning of the next file.

NOTE

- Files in the playback area can be played.
- The track name, file number and other file information for the currently playing file appear on the display.
- The **■** icon appears on the display when playback is stopped at the beginning of a file. The **■** icon appears when playback is paused in the middle of a file.
- When loop playback IN (start) and OUT (end) points are set between the current position and the end of the file, use these buttons to skip to those points. Press the **I◀◀** and **▶▶I** buttons as many times as necessary to move between files.

Playing recordings

When the Home screen is open and playback is stopped, press the **PLAY [▶]** button to start playback.

NOTE

- Files in the playback area can be played.
- You can also choose files for playback by name on the **BROWSE** screen.

Pausing

When the Home Screen is open and a file is playing back, press the **⏸/I (HOME) [■]** button to pause playback at the current position. (PAUSE)

Press the **PLAY [▶]** button again to restart playback from that position.

Stopping playback

When the Home screen is open and a file is playing back, press the **⏸/I (HOME) [■]** button to pause playback. Press the **⏸/I (HOME) [■]** button again to return to the beginning of the file. (STOP)

Searching backward and forward

When the Home Screen is open and a file is playing back or stopped, press and hold the **I◀◀** or **▶▶I** button to search the playback file backward or forward.

NOTE

Press and hold the **I◀◀** or **▶▶I** button to accelerate the search speed.

6 – Playback

Repeating playback (REPEAT)

You can repeatedly play one file or multiple files within a designated area.

1. Press the **MENU** button to open the MENU screen.
2. Use the + or – button to select **PLAY SETTING**, and press the **ENTER/MARK** or **▶▶I** button. This opens the **PLAY SETTING** screen.
3. Use the + or – button to select **REPEAT**, and press the **ENTER/MARK** or **▶▶I** button.



4. Use the + or – button to select a repeat mode.

CONTINUOUS (default)

All files in the playback area are played in sequence one time. (This setting is the ordinary playback mode.)

SINGLE

Only one file is played back in this mode. The selected file is played once without repeating.

The  icon appears on the Home Screen.

1 REPEAT

The current file is played repeatedly.

The  icon appears on the Home screen.

ALL REPEAT

All files in the selected playback area are played back repeatedly.

The  icon appears on the Home screen.

NOTE

If you start loop playback when **REPEAT** is not set to **CONTINUOUS**, it will automatically switch to **CONTINUOUS**.

5. After completing the setting, press the **⏪/I (HOME)** [**■**] button to return to the Home Screen and start playback.

Special playback control functions

The unit has some special playback control functions. For example, you can play a selected section of a file repeatedly or change the tempo of music without changing the pitch. You can also enhance the perceived overall sound pressure for comfortable listening when the playback sound is difficult to hear.

These playback control functions enable effective practice and analysis of musical passages.

Playback Control screen

Use the Playback Control screen to set the playback control functions.

While the Home Screen is open when stopped or playing back, press the **PB CONT** button to open the Playback Control screen.



This screen can be used to make settings for the playback speed and loop playback.

After you finish making settings on this screen, press the **⏪/I (HOME)** [**■**] button (or press the **PB CONT** button) to return to the Home screen.

Loop playback of a selection

With this function, you can continuously repeat (loop) the playback of a selection that you make.

1. While the Home Screen is open when stopped or playing back, press the **PB CONT** button to open the Playback Control screen.



2. Press the **PLAY** [**▶**] button to start playback, and press the **ENTER/MARK** button at the start point of the section that you want to play repeatedly. The current position is set as **IN** (start) point.

3. Press the **ENTER/MARK** button at the end point of the section that you want to play repeatedly.
The current position is set as OUT (end) point.

During loop playback the **I/O** indicator appears.

Press the **PB CONT** button to return to the Home Screen while maintaining the IN (start) and OUT (end) point and loop settings.



NOTE

- The **I/O Too Short** pop-up message appears if the section between the IN and OUT points is too short. Set them again. The section should be 1 second or longer.
- Press the **ENTER/MARK** button again to clear the IN and OUT points.
- To stop loop playback, press the **MENU** button when the Playback Control screen is open. Press the **MENU** button again to start loop playback between the set IN and OUT points.
- You cannot set the IN and OUT points in different files.
- The previous IN and OUT point settings are lost when you set the IN point on a different file.
- Accurate assignment of IN and OUT points is not always possible for variable bit rate (VBR) MP3 files.

Changing the playback speed (VSA)

This unit has a built-in variable speed audition (VSA) function to change the playback speed without changing the pitch.

CAUTION

VSA function cannot be used when a file that was recorded at 96 kHz sampling frequency or a file that was recorded in a mode other than MONO/STEREO or OVERDUB/MIX is selected. However, even in these cases, the **SPEED** icon will appear, and the playback speed can still be changed. Even though it will not affect this file, the playback speed adjustment will become effective when a 44.1/48kHz file is selected using the **◀◀** or **▶▶** button on the Home Screen.

When the Playback Control screen is open, press the + or - button to increase or decrease the playback speed.



The VSA function can change the playback speed in a range from 50% (0.5) to 200% (2.0) of the normal speed (in 0.1 increments).

Press the **PB CONT** button to return to the Home Screen while maintaining the set playback speed.

The **SPEED+** or **SPEED-** icon appears if the playback speed is set to a value larger or smaller than 1.0, respectively.

6 – Playback

Setting the playback equalizer

You can choose from different sound equalization settings to enhance listenability (PLAY EQ).

Use the **PLAY EQ** item on the **I/O SETTING** screen or the Quick menu to set the playback equalization.

Operation from the MENU screen

1. Press the **MENU** button to open the MENU screen.
2. Use the + or – button to select (highlight) **I/O SETTING** and press the **ENTER/MARK** or **▶▶▶** button. The **I/O SETTING** screen will open.
3. Use the + or – button to select (highlight) **PLAY EQ**, and press the **ENTER/MARK** or **▶▶▶** button.

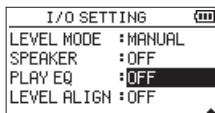

4. Use the + and – buttons to adjust the playback equalization. High (treble), middle and low frequencies can be adjusted, with + and – used to raise or lower the corresponding frequency bands.

Options: OFF (default), TREBLE+, TREBLE-, MIDDLE+, MIDDLE-, BASS+, BASS-

5. After completing the setting, press the **⏪/1 (HOME)** [■] button to return to the Home Screen.

Operation from the Quick menu

1. During playback when the Home Screen is open, press the **QUICK** button to open the Quick menu.



2. Use the + or – button to select (highlight) **PLAY EQ** and press the **ENTER/MARK** button.

This opens the **PLAY EQ** screen.

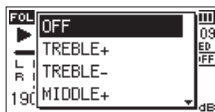

Options: OFF (default), TREBLE+, TREBLE-, MIDDLE+, MIDDLE-, BASS+, BASS-

3. Use the + or – button to select (highlight) a function, and press the **ENTER/MARK** button to enable it and return to the Home Screen.

Increasing perceived sound pressure to enhance listenability (LEVEL ALIGN)

If the playback sound is very small and indiscernible, the perceived overall sound pressure can be increased to enhance listenability. (Level Alignment)

Operation from the MENU screen

1. Press the **MENU** button to open the MENU screen.
2. Use the + or – button to select (highlight) **I/O SETTING** and press the **ENTER/MARK** or **▶▶▶** button. The **I/O SETTING** screen will open.
3. Use the + or – button to select (highlight) **LEVEL ALIGN** and press the **ENTER/MARK** or **▶▶▶** button.

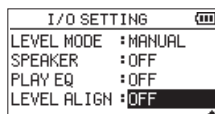

4. Use the + and – buttons to set the **LEVEL ALIGN** function.

Options: OFF (default), ON

5. After completing the setting, press the **⏪/1 (HOME)** [■] button to return to the Home Screen.

Operation from the Quick menu

1. During playback when the Home Screen is open, press the **QUICK** button to open the Quick menu.



2. Use the + or – button to select **LEVEL ALIGN** and press the **ENTER/MARK** button.
3. A screen to enable/disable the level alignment function appears.

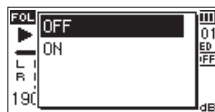

- Use the + or – button to select **0N**, and press the **ENTER/MARK** button to enable the level alignment function.

To disable the level alignment function, select (highlight) **OFF** and press the **ENTER/MARK** button.

NOTE

The level alignment function might not have much effect depending on the source of the sound (for example, a music file that has already had sound pressure adjusted).

Using the jump function

During playback or when paused, you can jump backward or forward from the current playback position by a set amount of time.

The same playback status will be retained after jumping.

The jump forward function can only be used during dictation playback mode, overwrite recording mode and with the file division function. Operation differs in these modes.

Use the **JUMP BACK** and **JUMP FWD** settings to set the backward and forward times.

JUMP BACK

Options: OFF, 1sec, 3sec (default), 5sec, 10sec, 30sec, 1min, 5min, 10min

JUMP FWD

Options: OFF, 1sec, 3sec, 5sec, 10sec (default), 30sec, 1min, 5min, 10min

Operation when not using dictation playback mode, overwrite recording mode or the file division function

Jumping back

During playback or when paused, press the ► button to jump back from the current position by the set **JUMP BACK** time.

Operation when using dictation playback mode, overwrite recording mode or the file division function

Jumping back

During playback or when paused, press the ► button to jump back from the current position by the set **JUMP BACK** time.

Jumping forward

During playback or when paused, press the ►► button to jump forward from the current position by the set **JUMP FWD** time.

NOTE

When jumping back, if the amount of time from the current playback position to the beginning of the file is less than the set "JUMP BACK" time, playback will jump to the beginning of the file. When jumping forward, if the amount of time from the current playback position to the end of the file is less than the set "JUMP FWD" time, playback will jump to the end of the file and pause.

Setting the jump back time

Operation from the MENU screen

- Press the **MENU** button to open the MENU screen.
- Use the + or – button to select **PLAY SETTING**, and press the **ENTER/MARK** or ►► button. This opens the **PLAY SETTING** screen.
- Use the + and – buttons to select (highlight) **JUMP BACK** and press the **ENTER/MARK** or ►► button.

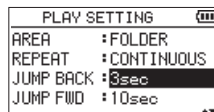

- Use the + and – buttons to set the jump back time.
- After completing the setting, press the **○/I (HOME) [■]** button to return to the Home Screen.

NOTE

If the amount of time to the beginning of the file is less than the set time, playback will jump to the beginning of the file and continue playing or pause.

Operation from the Quick menu

- Switch the operation mode of the unit to dictation playback mode.
- When stopped in dictation playback mode, press the **QUICK** button to open the Quick menu.

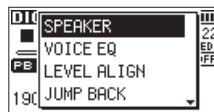

- Use the + or – button to select (highlight) **JUMP BACK** and press the **ENTER/MARK** button. The **JUMP BACK** time setting screen will open.

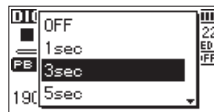

- Use the + or – button to select (highlight) a function, and press the **ENTER/MARK** button to enable it and return to the Home Screen.

6 – Playback

Setting the jump forward time

Operation from the MENU screen

1. Press the **MENU** button to open the MENU screen.
2. Use the + or – button to select **PLAY SETTING**, and press the **ENTER/MARK** or **▶▶1** button.
This opens the **PLAY SETTING** screen.
3. Use the + or – button to select (highlight) **JUMP FWD** and press the **ENTER/MARK** or **▶▶1** button.

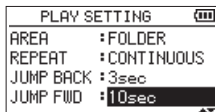

4. Use the + and - buttons to set the jump forward time.
5. After completing the setting, press the **⏪/1 (HOME) [■]** button to return to the Home Screen.

NOTE

If the amount of time to the end of the file is less than the set time, playback will jump to the end of the file and pause.

Operation from the Quick menu

1. When stopped in dictation playback mode, press the **QUICK** button to open the Quick menu.



2. Use the + or – button to select (highlight) **JUMP FWD** and press the **ENTER/MARK** button.
The **JUMP FWD** time setting screen will open.



3. Use the + or – button to select (highlight) a function, and press the **ENTER/MARK** button to enable it and return to the Home Screen.

Playback of files recorded using dual recording

When dual recording has been used, press and hold the **1/2 [SOLO]** button to select the main recording file or press and hold the **3/4 [SOLO]** button to select the backup recording file.

The file will be played for the input source that has an icon with a dark background.

NOTE

This function, which uses the **1/2 [SOLO]** and **3/4 [SOLO]** buttons to switch between files, finds files by the first 11 characters of their names. If file names are changed, this function will not work.

OVERDUB INPUT MUTE function (during playback)

SEPARATE MODE

Press the **3/4 [SOLO]** button to switch between the input sound and the 3/4 channel playback sound.

After overdubbing, you can use this to listen to the recorded file.

MIX MODE

Press the **1/2 [SOLO]** button to mute the input sound.

Solo function

Press and hold the **1/2 [SOLO]** button or **3/4 [SOLO]** button to enable the solo function.

Use for projects that have been recorded in 4-channel mode and in other cases when multiple files are being played back to monitor only one of the files.

You can check the solo status with the track status indications.

Features of the QUICK button

The **QUICK** button can be used for the following functions.

The functions of the **QUICK** button for different screens and states are as follows.

Screen	State	Menu item	Action	Page
Home Screen	Stopped/ paused	DELETE	Delete the current file.	see page 55
		DIVIDE	Divide the current file.	see page 55
		AUTO DIVIDE	Automatically divide the current file into multiple files at mark positions.	see page 56
		OVERWRITE	Record over (overwrite) the current file.	see page 57
		DICTIONATION PLAY	Enable dictation playback mode.	see page 58
	Playing back	MIXDOWN	Mix down the current file.	see page 59
		SPEAKER	Turn the built-in speaker on/off.	see page 20
		PLAY EQ	Set playback equalization.	see page 50
	Recording Standby	LEVEL ALIGN	Increase the perceived overall sound pressure to enhance listenability.	see page 50
		LEVEL MODE	Set the LEVEL MODE function.	see page 27
LOW CUT		Set the low-cut filter.	see page 37	
Home Screen DICTATION PLAY mode	MIC LR SWAP	Set mic left/right reversal.	see page 22	
	SPEAKER	Turn the built-in speaker on/off.	see page 20	
	VOICE EQ	This function enhances the vocal frequency range to make voices easier to hear in the playback sound.	see page 58	
	LEVEL ALIGN	Increase the perceived overall sound pressure to enhance listenability.	see page 50	
	JUMP BACK	Set the jump back time.	see page 51	
	JUMP FWD	Set the jump forward time.	see page 52	
Playback Control screen	MODE EXIT	Exit DICTATION PLAY mode.	see page 58	
	SPEAKER	Turn the built-in speaker on/off.	see page 20	
	PLAY EQ	Set playback equalization.	see page 50	
BROWSE screen	When file selected	LEVEL ALIGN	Increase the perceived overall sound pressure to enhance listenability.	see page 50
		FILE INFORMATION	Show file information for the selected file.	see page 41
		ADD PLAYLIST	Add the selected file to the playlist.	
		FILE SWAP	Swap recorded files in 4CH and OVERDUB (SEPARATE) modes.	
		FILE DELETE	Delete the selected file.	
	PROJECT DELETE	Delete the project that includes the selected file.		
	When folder selected	SELECT	Select the first file in the selected folder.	see page 43
ALL DEL		Deletes all files in the selected folder.		
FOLDER DELETE		Delete the selected folder and all files in it.		
Mixer Screen		MS DECODE	Turn MS DECODE on/off and select channels 1/2 and 3/4	see page 63

7 – Quick Operations

Screen	State	Menu item	Action	Page
OVERWRITE MODE		TO EDIT POINT	Move to where overwrite recording started.	see page 57
		UNDO	Restore to state before most recent overwrite recording.	see page 57
		MODE EXIT	Exit OVERWRITE mode.	see page 57

Quick menu

Press the **QUICK** button to open the Quick menu when you want to use it.

The content of the Quick menu differs according to the recorder status and operation mode.

Press the **QUICK** or ϕ /I (**HOME**) [■] button to close the Quick menu.



Quick menu when playback is stopped or paused

Deleting files

The currently selected file can be deleted without using the BROWSE screen.

1. To delete a file, select it using the \lll or \ggg button.
2. Open the Quick menu screen by pressing the **QUICK** button while the Home screen is open when stopped.



3. Use the + or – button to select **DELETE**.
4. Press the **ENTER/MARK** button. A confirmation screen for file deletion appears.



Press the **ENTER/MARK** button to delete the file, or press the ϕ /I (**HOME**) [■] button to cancel the deletion.

Dividing the selected file (DIVIDE)

A recorded file can be divided into two at a specified position.

1. Select a file to be divided using the \lll and \ggg buttons or the BROWSE screen.
2. While the Home Screen is open when stopped, press the **QUICK** button to open the Quick menu.



3. Use the + or – button to select **DIVIDE**, and press the **ENTER/MARK** button. The **DIVIDE** screen will open.



4. Use the + or – button to specify the position for file division, and press the **RECORD** [●] button. The following pop-up window appears.



5. Press the **ENTER/MARK** button to divide the file. If you press the ϕ /I (**HOME**) [■] button, the file will not be divided and the **DIVIDE** screen will reopen.

NOTE

- When the **DIVIDE** screen is open, you can press the **PLAY** [▶] button and set the divide position while playing the file.
- When the **DIVIDE** screen is open, press the **PLAY** [▶] button to pause/resume playback and press [◀▶] to move to the beginning or [▶|] to move to the end of the playback file. Adjust the position for file division using the + or – button. Press and hold the + or – button to move the position continuously.
- After dividing a file, two new files with “a” and “b” added to the end of the original file name are created.
(4-channel recording file example)

File names before dividing

180113_0003S12.wav

180113_0003S34.wav

File names after division

180113_0003aS12.wav (part before division point)

180113_0003aS34.wav (part before division point)

180113_0003bS12.wav (part after division point)

180113_0003bS34.wav (part after division point)

CAUTION

- MP3 files cannot be divided.
- If the SD card has insufficient open space, division might not be possible.
- Division is not possible if the file name would become more than 200 characters long.
- Division is not possible if the name that would be given to a new file is the same as the name of an existing file.
- If you divide a project that has virtual files, those files will also be divided at the same time.

TIP

Add marks during recording or playback at positions where you want to divide a file. (See “8 – Mark functions” on page 60)

Dividing the selected file automatically at marks (AUTO DIVIDE)

This function can automatically divide a file into multiple files at the positions of marks added during recording and playback.

1. Select a file to be divided using the [◀▶] and [▶|] buttons or the **BROWSE** screen.
2. While the Home Screen is open when stopped, press the **QUICK** button to open the Quick menu.

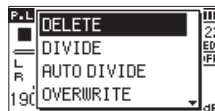

3. Use the + or – button to select **AUTO DIVIDE**, and press the **ENTER/MARK** button.
The **AUTO DIVIDE** screen will open.

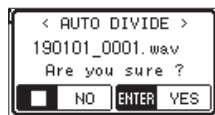

4. Press the **ENTER/MARK** button to divide the file and return to the Home screen.
Press the [O/I] (**HOME**) [■] button to return to the Home Screen without dividing.

NOTE

After dividing a file, new files with “_HH” added to the end of the original file name are created.

Example of 4-channel recording mode

File name before division

180113_0003S56.wav

180113_0003S78.wav

File names after division

180113_0003S56_01.wav (part before division point)

180113_0003S78_01.wav (part before division point)

180113_0003S56_02.wav (part after division point)

180113_0003S78_02.wav (part after division point)

CAUTION

- MP3 files cannot be divided.
- Division will not be possible if the time between any marks is less than two seconds.
- If the SD card has insufficient open space, division might not be possible.
- Division is not possible if the file name would become more than 200 characters long.
- Division is not possible if the name that would be given to a new file is the same as the name of an existing file.
- If you divide a project that has virtual files, those files will also be divided simultaneously.

TIP

Add marks during recording or playback at positions where you want to divide a file. (See "8 – Mark functions" on page 60)

Overwrite recording

A recorded file can be overwritten from a desired position.

Selecting a file to overwrite record

On the BROWSE screen, select the file to overwrite record.

NOTE

File skipping cannot be used to select files in overwrite recording mode.

Activating overwrite mode

1. While the Home Screen is open when stopped, press the **QUICK** button to open the Quick menu.

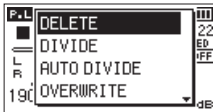

2. Use the + or – button to select (highlight) **OVERWRITE** and press the **ENTER/MARK** button.

This will activate overwrite recording mode.



3. Use the **◀◀**, **▶▶** and **▶** buttons to stop at the position where you want to start overwrite recording. At this time, using the **◀◀** or **▶▶** button will jump. (See "Using the jump function" on page 51)

Conducting overwrite recording

1. Press the **RECORD [●]** button.

The following pop-up window appears.



Press the **ENTER/MARK** button to close the pop-up window and start recording standby.

2. Press the **RECORD [●]** button again to start overwrite recording.
3. Press the **⏪/I (HOME) [■]** button to stop overwrite recording.

After stopping recording, the unit will return to the overwrite recording starting point and stop.

Checking the result of recording

Play the recorded file to check it.

NOTE

To return to the starting point of overwrite recording, you can select **TO EDIT POINT** from the Quick menu.

Undoing and redoing (UNDO/REDO)

In overwrite recording mode, you can undo an overwrite recording once to return to the immediately previous state. You can also restore (REDO) an undone change.

CAUTION

- Overwrite recording does not change the file name.
- Overwrite recording can be done as many times as you like, but only the file before the most recent overwritten recording will be retained. Overwriting again will delete the earlier file.

Ending overwrite recording mode

When the Home Screen is open and the unit is stopped, use the Quick menu to select **MODE EXIT**, and press the **ENTER/MARK** button.

This ends overwrite recording mode.

CAUTION

Ending overwrite recording mode will delete any file available for UNDO (REDO) operations.

Transcribing recorded files (DICTATION PLAY)

The DICTATION PLAY mode allows you to search for the parts of the selected file that you want to hear during playback, making it useful for transcribing meeting minutes, for example.

In DICTATION PLAY mode, the file skip function is disabled to prevent accidentally moving to the previous or next file. Select the file before enabling DICTATION PLAY Mode.

Enabling DICTATION PLAY mode

1. While the Home Screen is open when stopped, press the **QUICK** button to open the Quick menu.

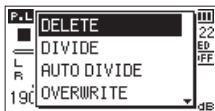

2. Use the + or – button to select (highlight) the **DICTATION PLAY** menu item, and press the **ENTER/MARK** button.

This will activate DICTATION PLAY mode.



Adjusting playback equalization

Using the Quick menu, you can make the audio easier to hear.

VOICE EQ: This makes the vocal frequency range easier to hear.

LEVEL ALIGN: The overall sound pressure is increased to enhance listenability.

Changing the playback position

Press **◀◀** briefly: jump back

Press **▶▶** briefly: jump forward

You can set the jump back and jump forward times from the Quick menu when stopped.

Ending DICTATION PLAY mode

When the Home Screen is open and the unit is stopped, use the Quick menu to select **MODE EXIT**, and press the **ENTER/MARK** button.

This exits DICTATION PLAY mode.

NOTE

- Recording is not possible in DICTATION PLAY mode.
- Menu operations are not possible in DICTATION PLAY mode.
- To use a menu, exit DICTATION PLAY mode temporarily.

Mixdown

This function combines three or four channels (a file each for channels 1/2 and channels 3/4) into one two-channel L/R file. At this time, you can adjust the effect level (SEND), left-right balance (PAN or BRL when mono), volume balance (LVL) for each channel freely on the MIXER screen. (See "10 – Mixer" on page 62)

1. Select a file to mix down using the ◀◀ and ▶▶ buttons or the BROWSE screen.
2. While the Home Screen is open when stopped, press the **QUICK** button to open the Quick menu.



3. Use the + or – button to select (highlight) MIXDOWN, and press the **ENTER/MARK** button. The MIXDOWN screen will open.



4. Press the **ENTER/MARK** button to start mixdown.
5. After mixdown completes, the playback Home screen opens with the mixed down file ready to play. (The project name number is the final number before mixdown increased by one.)
In this state, you can press the **PLAY** [▶] button to start playback of the mixed-down file.

CAUTION

If the playback file is mono, the file created will also be mono.

When mixing down mono files, set the BRL knob on the Mixer Screen to L12.

8 – Mark functions

Adding marks manually

When playing, recording or recording is paused, press the **ENTER/MARK** button to add a mark at the current point.

When a mark is added, a pull-up appears at the bottom of the display.



NOTE

- Mark information is stored in each file with numbers from 01 to 99.
- As the unit is compatible with the BWF format for WAV files, marks added to a WAV file during recording are stored in the file. Marks stored in the file are available when playing back the file using a BWF compliant software, etc.
- When using the built-in mics, the sound of pressing the button when adding a mark could be recorded. To avoid this, use a remote control to add marks.

Adding marks automatically to a recording

This function allows the unit to add marks automatically using AUTO REC.

On the REC SETTING screen, set the AUTO REC section MODE item to MARK.

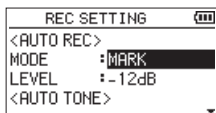

For details, see "Using the automatic recording function (AUTO REC)" on page 35.

Moving to mark positions

When stopped, paused or playing back, press the **I◀◀** or **▶▶I** button while pressing the **ENTER/MARK** to move between marks set in the selected file.

You can use this function like an index for cueing.

NOTE

You cannot move to marks in a different file.

Clearing marks

When stopped or paused, move to a mark, and press the **ENTER/MARK** button to clear that mark.

This unit has a built-in effect. They can also be applied to the output signal during playback.

When the effect is on, **FX OFF** appears at the top of the Home Screen as light on dark (**FX ON**).

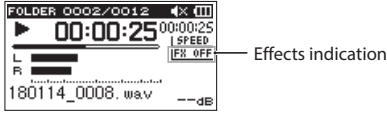

SOURCE (option)	Explanation
MIX (default value)	Apply the effect to the output during overdub/mix recording or during mixdown recording.
INT MIC	Apply the effect to signals input through the built-in mics
EXT IN	Apply the effect to signals input through external mics or equipment

When MIX is selected, you can set the level (SEND) of each signal sent to the effect on the Mixer Screen. (See "10 – Mixer" on page 62)

Setting the effect

1. Press the **MENU** button to open the MENU screen.
2. Use the + and – buttons to select the OTHERS menu, and press the **ENTER/MARK** or **▶▶I** button to open the OTHERS screen.
3. Use the + or – button to select EFFECT, and press the **ENTER/MARK** or **▶▶I** button.
The EFFECT screen will open.

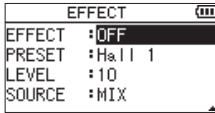

As shown in the above illustration, there are four setting items on the EFFECT screen.

Set each item using the **◀◀I**, **▶▶I**, + and – buttons.

EFFECT

Use this to turn the effect on or off. (Default: OFF)

PRESET

Select the preset for the effect being used. (default: Hall 1)

See the "Effects preset list" on page 61 for details about the preset effects.

LEVEL

Use this to change the output level of the effect selected with the PRESET item. Setting range: 0 - 20 (default: 10)

SOURCE

Select which input or output sound the effect is used on. (Default: MIX)

4. Use the + or – button to select the desired item and press the **ENTER/MARK** button or **▶▶I** button to access that item's settings.
5. Use the + or – button to set the desired value.
6. Press the **I◀◀** button to enable selection of settings.
7. Press the **⏪/I (HOME)** [**■**] button to return to the Home screen.

CAUTION

When the sampling frequency is set to 96 kHz, or a WAV file with a sampling frequency of 96 kHz is played, the built-in effects do not work. However, you can still set the built-in effects.

Effects preset list

Preset name	Effects
Hall 1 (default)	This is a bright reverb modeled after a large hall-like space.
Hall 2	This is a warm reverb modeled after a large hall-like space.
Room	This reverb is modeled on a small indoor space.
Studio	This reverb is modeled on a studio-like space.
Plate 1	This is a bright plate reverb.
Plate 2	This is a warm plate reverb.

10 – Mixer

This recorder has a mixer function that allows you to set the built-in effect, stereo balance and volume level for each channel.

During mixdown (See "Mixdown" on page 59) and playback, you can make fine adjustments to the recorded sound by using this.

Making mixer settings

1. From the Home screen, press the **MIXER** button to open the Mixer Screen.

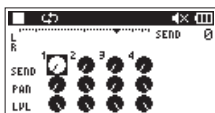

During 4-channel file playback

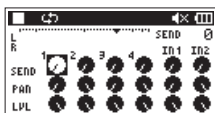

During overdubbing (mix) mode

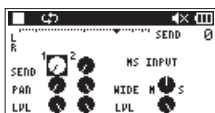

During 4-channel file playback (MS decoding of channels 3/4)

2. Use the **◀▶** and **▶▶** buttons and the **+** and **-** buttons to move to and select the item that you want to adjust. Each column is a channel and each row is a setting type.
3. Press the **ENTER/MARK** button to open the setting name and value in a pop-up window at the top right.

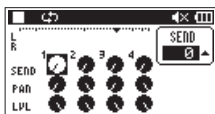

4. Use the **+** and **-** buttons to change the setting value.

Item	Setting range	Operation details
SEND	0–100	Adjusts the send level (0 (min.)–100 (max.)) of the selected effect used on the signal (See "Setting the effect" on page 61)
PAN/BAL	L12–C–R12	Adjusts left-right balance (L12 (left)–C (center)–R12 (right))
LVL	0–100	Volume level (0 (min.)–100 (max.))

5. Press the **ENTER/MARK** button to return to the previous screen where you can select the next setting that you want to adjust.

NOTE

- The mixer can be used when recording, in recording standby, playing back, paused or stopped.
- Even when the Mixer Screen is open, you can use the **PLAY** [▶] button to start playback and the **HOME** [■] button to pause playback.
- When the **REC MODE** screen **MS DECODE** item is on, **MS DECODE** on the Mixer Screen Quick menu cannot be used, and shows a message saying "Using by Input".

Using the MS decoder

When using MS mics to record, you have two decoding options. You can decode the input sound as you record or you can record as is and decode during playback.

Decoding the input sound as you record

1. Connect MS mics to the external input connectors. Connect the mid mic to the **EXT MIC L** connector and the side mic to the **EXT MIC R** connector. Decoding cannot be conducted properly if the mid and side mics are connected in reverse.
2. On the **REC MODE** screen, set the **REC MODE** item to **STEREO**, **DUAL** or **4CH**, and set the **SOURCE** item to **EXT IN 1/2** (no selection in **4CH** mode).
3. Set **MS DECODE** to **ON**.
4. Start recording to record a decoded MS signal.

Decoding the playback sound

1. Select a file that was recorded by MS mics with **MS DECODE** set to **OFF**.
2. When the Home screen is open, press the **MIXER** button to open the Mixer Screen.
3. Press the **QUICK** button to select the **CH** to be used by the MS decoder.

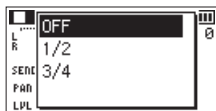

4. Start playback to decode during playback.

MS decoder settings

Use the **WIDE** parameter on the Mixer Screen to adjust the width of the sound.

To decode while recording, open the Mixer Screen while in recording standby.

MS INPUT will appear on the Mixer Screen when using the decoder on input. **MS MONITOR** will appear when using it on playback.

Item	Setting range	Operation details
WIDE	0–100	This adjusts the width of the sound.

At "0", mid is 100%. As the number increases, the amount of side signal increases.

CAUTION

If **MS DECODE** is set to **ON** on the **REC MODE** screen, it cannot be selected on the Mixer Screen (a "Using by Input" message appears).

To use the MS decoder during playback, set **MS DECODE** to **OFF** on the **REC MODE** screen.

11 – Tuning Instruments

This unit has a built-in tuner. By inputting sound from a musical instrument, you can tune it accurately while viewing the tuning meter shown in the display.

Using the tuner

Setting the tuner

1. Press the **MENU** button to open the MENU screen.
2. Use the + and – buttons to select the **OTHERS** menu, and press the **ENTER/MARK** or **▶▶** button to open the **OTHERS** screen.
3. Use the + or – button to select **TUNER**, and press the **ENTER/MARK** or **▶▶** button.
The Tuner Screen will open.



The Tuner Screen has a **CALIB** option to set the frequency of A.

Press the **◀◀** button to lower the frequency and the **▶▶** button to raise it.

Setting range: 435Hz - 445Hz

(in 1 Hz increments, default: 440Hz)

NOTE

When the Tuner Screen is open, press the **ENTER/MARK** button to reverse the display orientation.

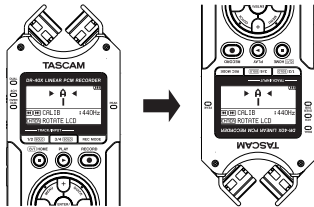

Tuning a musical instrument

1. Open the Tuner Screen and play a note on the instrument.
The closest pitch name will be shown above the center of the meter.
2. Tune the instrument so that the target pitch name appears and the center of the tuner lights.



A bar appears to the left or right of center if the sound is lower or higher than the target pitch. The bar becomes longer the more the input pitch differs from the target pitch.



CAUTION

The tuner can only be used with the built-in mics.

By connecting this unit with a computer using a USB cable, you can power the unit with USB bus power, and use the unit as an SD card reader and as a USB audio interface.

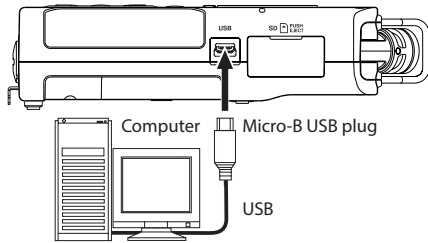

CAUTION

The unit should be connected directly with the computer instead of via a USB hub.

Powering the unit with USB bus power

When the unit is off

1. Connect the computer and the unit with a USB cable, and turn the unit on to open the USB screen.

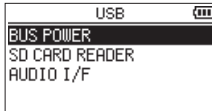

2. Use the + or – button to select **BUS POWER** and press the **ENTER/MARK** button to select power from the USB port and reopen the Home Screen.

When the unit is on

When operating on batteries, if you connect the computer and the unit with a USB cable, the unit will be powered from its **USB** port (USB bus power is used first).

NOTE

The same thing will also happen when using an AC adapter.

Using as an SD card reader

By connecting this unit with a computer using a USB cable, you can use it as an SD card reader.

You can transfer recorded audio files to a computer and also transfer audio files from a computer to the unit.

When the unit is off

1. Connect the computer and the unit with a USB cable, and turn the unit on to open the USB screen.

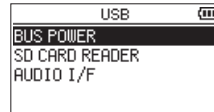

2. Use the + or – button to select **SD CARD READER** and press the **ENTER/MARK** button. The **SD CARD READER** screen will open.



When the unit is on

When operating on batteries, connect the unit and the computer with a USB cable

1. Press the **MENU** button to open the MENU screen.
2. Use the + or – button to select **USB**, and press the **ENTER/MARK** button to open the USB screen.

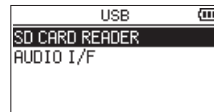

3. Use the + or – button to select **SD CARD READER** and press the **ENTER/MARK** button. The **SD CARD READER** screen will open.



Disconnecting the unit from a computer

Before disconnecting the computer and the unit, use the proper procedures for the computer to unmount the unit, and press the **I◀◀** button.

Press the **I◀◀** button to disconnect from the computer and return to the Home Screen.

Transferring files from a computer

1. Click the **"DR-40X"** drive on the computer screen to show the **"MUSIC"** and **"UTILITY"** folders.
2. Drag and drop files on the computer that you want to transfer to the unit to the **"MUSIC"** folder.

TIP

- You can manage the **"MUSIC"** folder from the computer.
- You can create subfolders in the **"MUSIC"** folder up to the second level for use with this unit. Only two levels of folders can be created. This unit cannot recognize subfolders and audio files on the third level or below.
- Since you can set this unit to only play the contents of a specific folder, you can organize tracks into genres, artists or other categories as you like.
- If you name the subfolders and music files, these names will appear on the screen of this unit.

Using as a USB audio interface

By connecting this unit with a computer using a USB cable, you can use it as a USB audio interface.

When the unit is off

1. Connect the computer and the unit with a USB cable, and turn the unit on to open the USB screen.

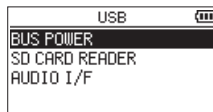

2. Use the + or – button to select (highlight) **AUDIO I/F**, and press the **ENTER/MARK** button. The **AUDIO I/F** screen will open.

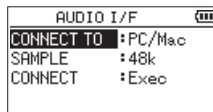

When the unit is on

When operating on batteries, connect the unit and the computer with a USB cable

1. Press the **MENU** button to open the **MENU** screen.
2. Use the + or – button to select **USB**, and press the **ENTER/MARK** button to open the **USB** screen.

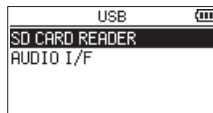

3. Use the + or – button to select (highlight) **AUDIO I/F**, and press the **ENTER/MARK** button. The **AUDIO I/F** screen will open.

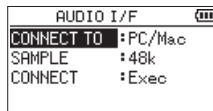

Setting the connected device type

1. When the **AUDIO I/F** screen is open, use the + or – button to select (highlight) **CONNECT TO**, and press the **ENTER/MARK** button.

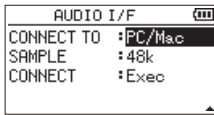

2. Use the + and – buttons to set the type of connected device.

Options: PC/Mac (default), iOS

NOTE

- With Windows, an ASIO driver for the DR-X series can be used. Check the page for this product on the TASCAM website (<https://tascam.com/us/>) for details.
- With a Mac, the standard OS driver will be used, so there is no need to install any software.
- If the connected device type is iOS, this unit will operate on batteries.
- Lightning to USB Camera Adapter, for example, is necessary to connect to an iOS device.

Connecting

1. When the **AUDIO I/F** screen is open, use the + or – button to select (highlight) **CONNECT**, and press the **ENTER/MARK** button.

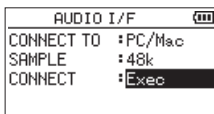

2. Press the **ENTER/MARK** button to enable audio interface mode and return to the Home Screen.

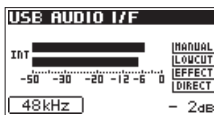

NOTE

When in audio interface mode, press the **MENU** button to access the following functions.

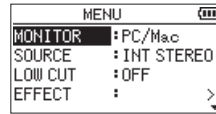

- **MONITOR:** Set to **DIRECT** to mix the mic input and computer output sounds, enabling input monitoring without lag.
- **SOURCE:** Select the input source.
- **LOW CUT:** Set the cutoff frequency of the low-cut filter during input.
- **EFFECT:** Open the effect settings screen.
- **DISCONNECT:** End the USB audio interface mode connection.

13 – Settings and Information

Viewing information (INFORMATION)

Use the **INFORMATION** screen to view various types of information about this unit.

Follow the procedures below to view the **INFORMATION** screen.

1. Press the **MENU** button to open the **MENU** screen.
2. Use the + and – buttons to select the **OTHERS** menu, and press the **ENTER/MARK** or **▶▶I** button to open the **OTHERS** screen.
3. Use the + or – button to select **INFORMATION**, and press the **ENTER/MARK** or **▶▶I** button.

The **INFORMATION** screen contains the following three pages. Use the + and – button to move through these pages.

- **File information page (FILE)**
Shows information about the currently loaded file.
- **Card information page (CARD)**
Shows the use status of the currently inserted SD card.
- **System information page (SYSTEM)**
Shows the unit's system setting information and firmware version.

File information page

The **FILE** page shows information about the currently selected file.

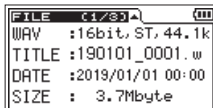

FILE	C1/S1/A	III
WAV	:16bit, ST, 44.1k	
TITLE	:190101_0001.w	
DATE	:2019/01/01 00:00	
SIZE	: 3.7Mbyte	

WAV, BWF or MP3

Shows the audio file type.

For WAV or BWF files, bit length, stereo/mono, and sampling frequency (Hz) also appear.

For MP3 files, the bit rate (kbps), CBR (constant bit rate) or VBR (variable bit rate) type, and sampling frequency (Hz) also appear. (CBR: Constant Bit Rate, VBR: Variable Bit Rate)

TITLE

Shows the file name.

If an MP3 file has ID3 tag title information that information appears.

DATE

Date of file creation

SIZE

File size

Card information page (CARD)

The **CARD** page shows the status of the currently inserted SD card.

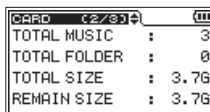

CARD	C2/S3/A	III
TOTAL MUSIC	: 3	
TOTAL FOLDER	: 0	
TOTAL SIZE	: 3.7G	
REMAIN SIZE	: 3.7G	

TOTAL MUSIC

Shows the number of playable files in the **MUSIC** Folder.

TOTAL FOLDER

Shows the total number of folders in the **MUSIC** folder.

TOTAL SIZE

Shows the total SD card capacity.

REMAIN SIZE/USED SIZE

Shows the amount of unused/used capacity on the SD card.

Press the **◀◀** or **▶▶** button to switch between **REMAIN SIZE** and **USED SIZE**.

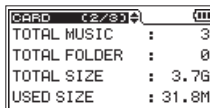

CARD	C2/S3/A	III
TOTAL MUSIC	: 3	
TOTAL FOLDER	: 0	
TOTAL SIZE	: 3.7G	
USED SIZE	: 31.8M	

System information page (SYSTEM)

The **SYSTEM** page shows information about the system settings and firmware version of this unit.

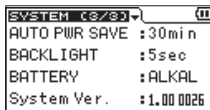

SYSTEM	C3/S3/A	III
AUTO PWR SAVE	: 30min	
BACKLIGHT	: 5sec	
BATTERY	: ALKAL	
System Ver.	: 1.00 0026	

AUTO PWR SAVE

This shows the setting of the automatic power saving function.

BACKLIGHT

This shows the backlight time setting.

BATTERY

This shows the battery type setting.

System Ver.

This shows the system firmware version.

System Settings

On the **SYSTEM** screen, you can change various settings to optimize the device for the use environment and conditions. You can also restore factory default settings and format SD cards, for example.

You can also initialize the unit and format the SD card.

1. Press the **MENU** button to open the **MENU** screen.
2. Use the + or – button to select (highlight) **SYSTEM** and press the **ENTER/MARK** or **▶▶** button. This opens the **SYSTEM** screen.

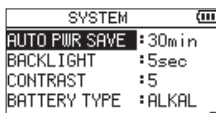

The following settings can be made for the items on the **SYSTEM** screen.

Use the **◀◀** or **▶▶** button and the + or – button to set each item.

Setting the automatic power saving function

The **AUTO PWR SAVE** item sets the amount of time from when the unit last operated or was used until it turns off automatically if it is powered by batteries.

Options: OFF (does not turn off automatically), 3min, 5min, 10min, 30min (default)

Setting the backlight

Use **BACKLIGHT** to set the time until the backlight automatically turns OFF after the last operation when powered by batteries.

Options: OFF (backlight off), 5sec (default), 10sec, 15sec, 30sec, ALWAYS (always on)

Adjusting the display contrast

Use **CONTRAST** to adjust the display contrast.

Options: 1–20 (default: 5)

Setting the battery type

Use the **BATTERY TYPE** item to set the battery type. This setting is used to show the amount of remaining battery charge and determine if the unit has enough power for normal operation.

Options: ALKAL (alkaline batteries, default), Ni-MH (nickel-metal hydride batteries)

Setting the phantom power voltage

Use the **PHANTOM VOLT** item to set the voltage of the phantom power supplied when external mics that require it are connected.

Options: +24V, +48V (factory setting)

Setting the language

Use the **LANGUAGE** item to set the language shown on the display.

1. Use the + or – button to select (highlight) **LANGUAGE** and press the **ENTER/MARK** or **▶▶** button.

Options

ENG : use English
 日本語 : use Japanese
 FRA : use French
 ESP : use Spanish
 DEU : use German
 ITA : use Italian
 POR : use Portuguese
 RUS : use Russian
 中文 : use Chinese
 한글 : use Korean

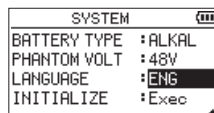

2. Press the **ENTER/MARK** button to open a confirmation pop-up message.



3. Press the **ENTER/MARK** button to confirm the language selection. To cancel language selection, press the **⏪** (**HOME**) [**■**] button.

The wrong language was set accidentally.

- After pressing the **⏪** (**HOME**) [**■**] button to turn the unit off (put it in standby), while pressing the **MENU** button, press the **⏪** (**HOME**) [**■**] button again. The language selection menu will appear, and you will be able to select the language.

Restoring the factory settings

Use the **INITIALIZE** item to restore the various settings of this unit to their factory settings.

1. Use the + or – button to select **INITIALIZE**, and press the **ENTER/MARK** or **▶▶I** button to highlight **Exec.**
2. Press the **ENTER/MARK** button again to open a confirmation pop-up window.



3. Press the **ENTER/MARK** button to initialize the unit. Press **⏪/I (HOME) [■]** to cancel initialization.

Formatting SD cards

Use the **QUICK FORMAT** item to format an SD card.

Formatting an SD card erases all music files on the card and automatically creates new “**MUSIC**” and “**UTILITY**” folders as well as a “**dr-1.sys**” file.

1. Use the + or – button to select **QUICK FORMAT**, and press the **ENTER/MARK** or **▶▶I** button to highlight **Exec.**
2. Press the **ENTER/MARK** button again to open a confirmation pop-up window.



3. Press the **ENTER/MARK** button to format the SD card. Press **⏪/I (HOME) [■]** to cancel formatting the SD card.

Completely formatting SD cards

Use the **FULL FORMAT** item to completely format an SD card. Full formatting checks the SD card memory for errors while formatting, so it takes more time than quick formatting.

Formatting an SD card erases all music files on the card and automatically creates new “**MUSIC**” and “**UTILITY**” folders as well as a “**dr-1.sys**” file.

1. Use the + or – button to select **ERASE FORMAT**, and press the **ENTER/MARK** or **▶▶I** button to highlight **Exec.**
2. Press the **ENTER/MARK** button again to open a confirmation pop-up window.



3. Press the **ENTER/MARK** button to format the SD card completely. Press **⏪/I (HOME) [■]** to cancel formatting the SD card.

CAUTION

When formatting an SD card, the unit should be operating on AC power supplied through a TASCAM PS-P520E adapter (sold separately), USB bus power supplied from a computer, or batteries with sufficient remaining power. If the power fails during formatting, the formatting may not occur correctly.

NOTE

- Using the **FULL FORMAT** option might restore an SD card that has decreased writing performance due to repeated use.
- **FULL FORMAT** checks the memory for errors while formatting, so it takes more time than **QUICK FORMAT**.

Setting the file name format

You can select the format of names given to files recorded by this unit.

1. Press the **MENU** button to open the **MENU** screen.
2. Use the + and – buttons to select the **OTHERS** menu, and press the **ENTER/MARK** or **▶▶** button to open the **OTHERS** screen.
3. Use the + or – button to select **FILE NAME**, and press the **ENTER/MARK** or **▶▶** button.
The **FILE NAME** screen will open.

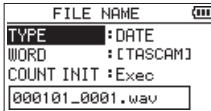

Use the **◀◀** or **▶▶** button and the + or – button to set each item.

On this screen you can make the following settings for each item.

File name format

The **TYPE** item can be set to either **WORD** or **DATE**.

Options: **WORD**, **DATE** (default)

WORD: The 6 characters set with **WORD** are used for file names.

Example: TASCAM_0001S12.wav

DATE: The date is used as the file name.

Example: 110101_0000.wav

NOTE

The date is set using the unit's internal clock. (See "Setting the date and time" on page 18.)

Setting the WORD item

To set the **WORD** item, use the **◀◀** and **▶▶** buttons to move the cursor, and use the + or – button to select the character.

In addition to the alphabet and numbers, the following characters can be used: ! # \$ % & ' () + , - . ; = @ [] ^ _ ` { } ~

Resetting the number

Select **COUNT INIT**, and press the **ENTER/MARK** button to execute it. The next file created after this will have the number "0001" after the characters set using the **WORD** item.

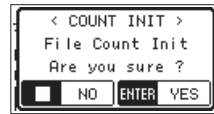

14 – Using the REMOTE jack

This unit has a **REMOTE** jack. This unit can be operated with a connected TASCAM RC-3F footswitch remote control (sold separately) or TASCAM RC-10 wired remote control (sold separately).

Footswitch (TASCAM RC-3F)

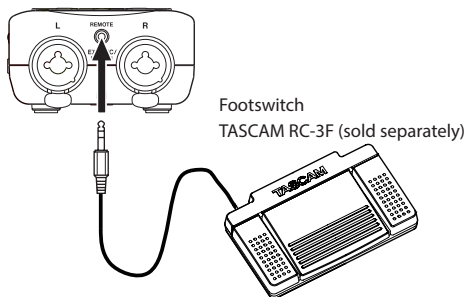

Setting footswitch operation

Use the **REMOTE** Screen to set the footswitch.

1. Press the **MENU** button to open the **MENU** screen.
2. Use the + and – buttons to select the **OTHERS** menu, and press the **ENTER/MARK** or **▶▶I** button to open the **OTHERS** screen.
3. Use the + or – button to select **REMOTE**, and press the **ENTER/MARK** or **▶▶I** button to open the **REMOTE** screen.

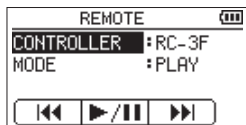

4. Use the + or – button to select (highlight) **CONTROLLER** menu item, and press the **ENTER/MARK** or **▶▶I** button.
5. For the **CONTROLLER** item, use the + or – button to select **RC-3F**. (Default: RC-3F)
6. Use the + or – button to select (highlight) **MODE** item, and press the **ENTER/MARK** or **▶▶I** button.

7. Use the + or – button to change the **MODE** item.

Options: **PLAY** (default), **RECORD1**, **RECORD2**, **MINUTES**

MODE	Footswitch		
	L	C	R
PLAY	◀◀	▶▶/	▶▶▶
RECORD 1	■	●/	INC
RECORD 2	■	●/	MARK
MINUTES	↺	▶▶/	USA

INC: track increment function

MARK: mark function

USA: Variable speed function on/off

↺: Jump back function

(All other functions are the same as the main unit.)

8. After completing the setting, press the **⏏** (**HOME**) **[■]** button to return to the Home Screen.

Using the footswitch

Press a pedal on the footswitch to operate the unit. The function of each pedal corresponds to the assignment shown on the **REMOTE** screen.

Remote control (TASCAM RC-10)

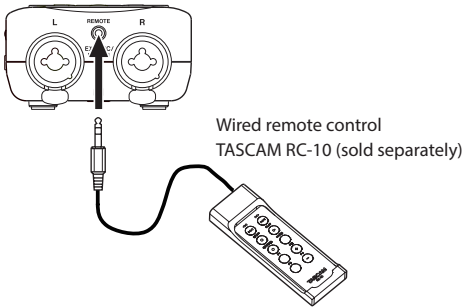

Using the wired remote control

Press the function buttons (F1 – F4) on the wired remote control to use the function assigned on the REMOTE screen.

Overview of mode functions

MODE	Function buttons			
	F1	F2	F3	F4
---	1/2 [SOLO]	3/4 [SOLO]	INPUT VOL +	INPUT VOL -

Setting the wired remote control

Use the REMOTE Screen to set the wired remote control.

1. Press the **MENU** button to open the MENU screen.
2. Use the + and – buttons to select the **OTHERS** menu, and press the **ENTER/MARK** or **▶▶** button to open the **OTHERS** screen.
3. Use the + or – button to select **REMOTE**, and press the **ENTER/MARK** or **▶▶** button to open the **REMOTE** screen.
4. Use the + or – button to select **CONTROLLER**, and press the **ENTER/MARK** or **▶▶** button.
5. For the **CONTROLLER** item, use the + or – button to select **RC-10**. (Default: RC-3F)

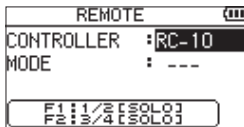

6. After completing the setting, press the **⏪/I (HOME) [■]** button to return to the Home Screen.

15 – Messages

The following is a list of pop-up messages.

Refer to this list if one of these pop-up messages appears on the DR-40X and you want to check the meaning or determine a proper response.

Message	Details and responses
File Name Err	The DIVIDE function cannot be used if the file name is 197 characters or more. Connect the unit to a computer and edit the file name to 196 characters or less.
Dup File Name	The DIVIDE function would cause the file name to be the same as that of an existing file in the same folder. The DIVIDE function adds "_a" and "_b" to the ends of the file names. Before choosing the DIVIDE function, connect the unit to a computer and edit the file name.
File Not Found	The file added to the playlist cannot be found or a file could be damaged. Please check that file.
Non-Supported	The audio file is not a supported format. Please see "11 - Connecting with a computer" for file formats that this unit can use.
Battery Empty	The batteries are almost out of power. Replace the batteries.
I/O Too Short	The IN and OUT points are too close together. Set them with at least 1 second between them.
File Not Found PLAYLIST	A file in the Playlist cannot be found. Please confirm that the file is still in the Music folder.
No PLAYLIST	No files have been added to the Playlist. Add a file to the playlist or change the AREA to something besides PLAYLIST.
PLAYLIST FULL	The playlist is full. You cannot add more than 99 tracks to the Playlist.
MBR Error Init CARD	The SD card is not formatted properly or the card is broken. Change the SD card or press the ENTER/MARK button while this message is being shown to format the card. <u>Formatting will erase all the data on the SD card.</u>
Format Error Format CARD	The SD card is not formatted properly or the card is broken. This message also appears if the card was formatted using a computer connected by USB or if an unformatted card is inserted in the unit. Always use the DR-40X to format SD cards to be used with it. Change the SD card or press the ENTER/MARK button while this message is being shown to format the card. <u>Formatting will erase all the data on the SD card.</u>
File Not Found Make Sys File	The system file needed to use this unit is missing. When this message appears, press the ENTER/MARK button to automatically create a system file.
Invalid SysFile Make Sys File	The system file required to operate this unit is invalid. When this message appears, press the ENTER/MARK button to automatically create a new system file.
Invalid Card Change Card	Something might be wrong with the SD card. Change the SD card.
Write error REC continue	Writing to the SD card was not in time. This has caused audio to be interrupted and noise to occur. A mark is added at the point when audio was interrupted.
Card slow Check BOF mark	SD card writing performance has become worse. A mark has been added at the point when audio was interrupted because writing to the SD card timed out. Check the audio around the mark. Execute the full format function or change the SD card.
Card Full	The SD card has no remaining space. Erase unnecessary files or move them to a computer to make open space.
Can't Divide	The selected division point is not suitable. (It is too close to the beginning or end of the track.)
Max File Size	The file is larger than the designated size Another possibility is that the recording time has exceeded 24 hours when the total number of folders and files was already at the limit (5000).
File Full	The total number of folders and files exceeds 5000. Erase unnecessary folders and files or move them to a computer.
Card Error	The SD card could not be recognized properly. Change the card.
Current File MP3	MP3 files cannot be divided.

Message	Details and responses
File Protected	The file is read only and cannot be erased.
No Card	No SD card is loaded in the unit. Insert a recordable SD card.
No PB File	There is no file that can be played back. The file might be damaged.
No MUSIC File	There is no playback file, so DIVIDE cannot be executed.
Cannot overdub! See REC setting	You cannot overdub when there are two 96kHz WAV/BWF or MP3 format playback files. Mix them down to one file before overdubbing.
Using by Input	The MS decoder is being used on the input. To use it on monitoring, on the REC MODE screen, set MS DECODE to OFF.
Now DUAL REC	To change the LEVEL MODE function when in dual recording mode, use the REC MODE screen.
Now OVERDUB	The MS decoder cannot be used in overdubbing mode.
Virtual File!	Virtual files cannot be played back or added to playlists. To play the file back use FILE SWAP.
Can't File Swap	FILE SWAP cannot be used with projects that have only one file.
Now Auto Rec	When auto-recording is enabled, the Self Timer does not function. Set AUTO REC to OFF on the REC SETTING screen.
Not Continued	<p>If any of these errors occurs, turn the unit's power off and restart it.</p> <p>If the power cannot be turned off, remove the batteries, disconnect the TASCAM PS-P520E AC adapter (sold separately), and/or disconnect the USB cable for bus power supply.</p> <p>If these error messages continue to appear frequently, please contact the store where you purchased this unit or TASCAM customer support service.</p>
File Error	
Can't Save Data	
Player Error	
Device Error	
Writing Failed	
Sys Rom Err	
System Err XX (XX is a number.)	

16 – Troubleshooting

If you are having trouble with the operation of this unit, please double-check the following before seeking repair. If these measures do not resolve the issue, please contact the retailer where you purchased this unit or a TASCAM customer support service service.

Power will not turn ON.

- Confirm that batteries are installed correctly.
- Confirm that the **HOLD** switch is not set.

The unit turns off automatically.

- Check the automatic power saving function setting. Set it to "Off" to prevent the power from turning off automatically. (See "Setting the automatic power saving function" on page 69)

The SD card is not recognized.

- Confirm that the SD card is inserted completely.

No sound is output or sound is not output from the speaker.

- Confirm that the output volume is not lowered it too much.
- Confirm that the speaker setting is on. Even if the speaker setting is on, sound will not be output from the speaker when headphones are connected or when the unit is recording or in recording standby.

Recording is not possible.

- Confirm that the **REC** indicator is lit. If the **REC** indicator is blinking, the unit is in recording standby.
- Check the remaining available recording time shown on the Recording Screen.

The recorded sound is quiet or distorted.

- Check the input level setting.

The unit is not recognized by a computer connected using a USB cable.

- Confirm that the connected computer uses a compatible operating system.
- The USB function used must be selected from the menu to enable a computer to recognize this unit.
- Confirm that the USB cable is not designed only for charging.
- Confirm that the connection is not being made through a USB hub.

Sound skips or noise occurs when in USB audio interface mode.

For Windows

- Performance options
Select "Adjust for best performance".
- Power options
Select "High performance".
- Use an ASIO driver for the DR-X series.
Check the page for this product on the TASCAM website (<https://tascam.com/us/>) for details.

The wrong language was set accidentally.

- After pressing the ϕ /I (**HOME**) [■] button to turn the unit off (put it in standby), while pressing the **MENU** button, press the ϕ /I (**HOME**) [■] button again.
The language selection menu will appear, and you will be able to select the language.

Ratings

Recording media

- SD card (64 MB - 2 GB)
- SDHC card (4 GB - 32 GB)
- SDXC card (48 GB - 128 GB)

Recording/playback formats

- BWF: 44.1/48/96kHz, 16/24 bit
- WAV: 44.1/48/96kHz, 16/24 bit
- MP3: 44.1/48 kHz, 32/64/96/128/192/256/320 kbps

Number of channels

- 4 channels (stereo × 2)
-

Input/output ratings

Analog audio input and output ratings

EXT MIC/LINE IN jacks (XLR connectors can provide phantom power)

- Connector: XLR-3-31
(1: GND, 2: HOT, 3: COLD) (phantom power supported)
- 6.3 mm (1/4") TRS Standard jack
(Tip: HOT, Ring: COLD, Sleeve: GND)

When EXT IN switch set to MIC, MIC + PHANTOM

- Input impedance: 2.2 k Ω
- Nominal input level: -19 dBV
- Maximum input level: -3 dBV

When EXT IN switch set to LINE

- Input impedance: 10 k Ω or more
- Nominal input level: +4 dBu
- Maximum input level: +20 dBu

LINE OUT jack

- Connector: 1/8" (3.5mm) stereo mini jack
- Output impedance: 12 Ω
- Reference output level: -14 dBV (with 10 k Ω load)
- Maximum output level: +2 dBV (with 10 k Ω load)
- Maximum output: 20 mW + 20 mW (when connected to headphones, 32 Ω load)

Built-in speaker

- 0.3W (mono)

Control input/output ratings

USB port

- Connector type: Micro-B
- Format
 - USB 2.0 HIGH SPEED mass storage class
 - USB1.1 FULL SPEED audio class

REMOTE jack

- Connector: 2.5mm TRS jack
-

Audio performance

Frequency response

- 20 Hz - 20 kHz +1/-3 dB
(EXT IN to LINE OUT, Fs 44.1 kHz, JEITA)
- 20 Hz - 22 kHz +1/-3 dB
(EXT IN to LINE OUT, Fs 48 kHz, JEITA)
- 20 Hz - 40 kHz +1/-3 dB
(EXT IN to LINE OUT, Fs 96 kHz, JEITA)

Total harmonic distortion

- 0.05% or less
(EXT IN to LINE OUT, 44.1/48/96kHz sampling frequency, JEITA*)

S/N ratio

- 92 dB or higher
(EXT IN to LINE OUT, 44.1/48/96kHz sampling frequency, JEITA*)
 - *Conforms to JEITA CP-2150
-

Other specifications

Power

- 3 AA batteries (alkaline or Ni-MH)
- USB bus power from a computer
- AC adapter (TASCAM PS-P520E, sold separately)

Power consumption

- 1.7 W (maximum)

Current consumption

- 0.34 A (maximum)

17 – Specifications

Battery operation time (continuous operation)

• Using alkaline batteries (EVOLTA)

Format	Continuous operation time	Note
When recording 2-channel 96kHz/24-bit WAV	About 14.5 hours	With built-in stereo mic input
When recording 2-channel 44.1kHz/16-bit WAV	About 18 hours	With built-in stereo mic input
When recording 2-channel 44.1kHz/16-bit WAV	About 6.5 hours	When supplying phantom power (+48V, 3mA load × 2)
When recording 2-channel 44.1kHz/128kbps MP3	About 16 hours	With built-in stereo mic input
When recording 4-channel 96kHz/24-bit WAV	About 8.5 hours	With built-in stereo mic and line input
When recording 4-channel 44.1kHz/16-bit WAV	About 9 hours	With built-in stereo mic and line input
When recording 4-channel 44.1kHz/128kbps MP3	About 9 hours	With built-in stereo mic and line input
When playing 2-channel 96kHz/24-bit WAV	About 14 hours	When using headphones
When playing 2-channel 44.1kHz/16-bit WAV	About 19.5 hours	When using headphones
When playing 2-channel 44.1kHz/128kbps MP3	About 16.5 hours	When using headphones
When playing 4-channel 96kHz/24-bit WAV	About 14 hours	When using headphones
When playing 4-channel 44.1kHz/16-bit WAV	About 16 hours	When using headphones
When playing 4-channel 44.1kHz/128kbps MP3	About 16.5 hours	When using headphones

Recording: JEITA recording time Playback: JEITA music playback time

• Using NiMH batteries (eneloop)

Format	Continuous operation time	Note
When recording 2-channel 96kHz/24-bit WAV	About 11 hours	With built-in stereo mic input
When recording 2-channel 44.1kHz/16-bit WAV	About 16 hours	With built-in stereo mic input
When recording 2-channel 44.1kHz/16-bit WAV	About 5.5 hours	When supplying phantom power (+48V, 3mA load × 2)
When recording 2-channel 44.1kHz/128kbps MP3	About 12.5 hours	With built-in stereo mic input
When recording 4-channel 96kHz/24-bit WAV	About 7.5 hours	With built-in stereo mic and line input
When recording 4-channel 44.1kHz/16-bit WAV	About 7.5 hours	With built-in stereo mic and line input
When recording 4-channel 44.1kHz/128kbps MP3	About 8 hours	With built-in stereo mic and line input
When playing 2-channel 96kHz/24-bit WAV	About 12 hours	When using headphones
When playing 2-channel 44.1kHz/16-bit WAV	About 15.5 hours	When using headphones
When playing 2-channel 44.1kHz/128kbps MP3	About 13 hours	When using headphones
When playing 4-channel 96kHz/24-bit WAV	About 11.5 hours	When using headphones
When playing 4-channel 44.1kHz/16-bit WAV	About 12.5 hours	When using headphones
When playing 4-channel 44.1kHz/128kbps MP3	About 13.5 hours	When using headphones

Recording: JEITA recording time Playback: JEITA music playback time

NOTE

The battery operation times (during continuous operation) could vary depending on the media being used.

Dimensions (W x H x D)

70 × 155 × 35mm (2.67" × 6.22" × 1.02") (when the microphone pair is closed)

90 × 155 × 35mm (3.54" × 6.22" × 1.02") (when the microphone pair is open)

Weight

282g (including batteries)/213 g (not including batteries)

Operating temperature

0°C–40°C (32°F–104°F)

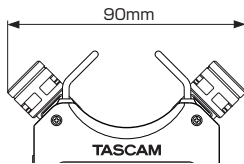
Dimensional drawings

Opened mic dimension

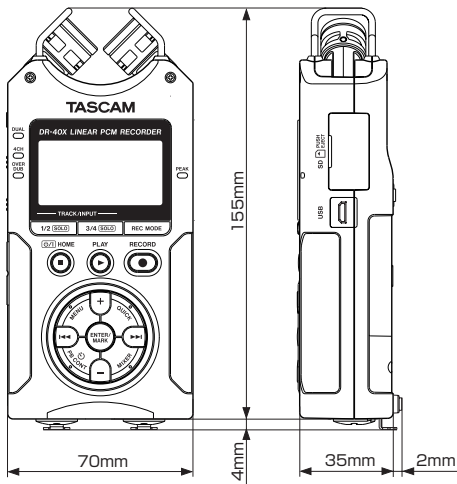

- Illustrations and other depictions may differ in part from the actual product.
- Specifications and external appearance may be changed without notification to improve the product.

TASCAM

TEAC CORPORATION

Phone: +81-42-356-9143
1-47 Ochiai, Tama-shi, Tokyo 206-8530 Japan

<https://tascam.jp/jp/>

TEAC AMERICA, INC.

Phone: +1-323-726-0303
10410 Pioneer Blvd. Suite #1, Santa Fe Springs, California 90670, U.S.A.

<https://tascam.com/us/>

TEAC UK Ltd.

Phone: +44-1923-797205
Meridien House, 69-71 Clarendon Road, Watford, Herts, WD17 1DS, United Kingdom

<https://www.tascam.eu/en/>

TEAC EUROPE GmbH

Phone: +49-611-71580
Bahnstrasse 12, 65205 Wiesbaden-Erbenheim, Germany

<https://www.tascam.eu/de/>

TEAC SALES & TRADING(SHENZHEN) CO., LTD

Phone: +86-755-88311561~2
Room 817, Xinian Center A, Tairan Nine Road West, Shennan Road, Futian District, Shenzhen, Guangdong Province 518040, China

<https://tascam.cn/cn/>